

# COMEUP WINCH

Getting you through since 1975



## UTILITY DUTY WINCH --- INSTRUCTION GUIDE



# COMEUP WINCH

## Utility Duty Winch

Limited Lifetime Warranty for Mechanical Components

Limited One (1) Year Warranty for Electrical Components

### WARRANTY

Comeup Industries Inc. (COMEUP) warrants to the original purchaser that the mechanical components of the COMEUP Utility Duty Winch will be free of defects in material and workmanship for the lifetime of the winch and the electrical components will be free of defects in material and workmanship for a period of one (1) year from the original date of purchase. All COMEUP mounting kits and other accessories carry a one (1) year limited warranty against defects in material workmanship.

This warranty applies only to the original purchaser of the winch. To obtain any warranty service, the purchaser under this Limited Warranty is requested to advise COMEUP or its authorized distributors on any claim. The purchaser must provide a copy of the purchase receipt bearing the winch serial number, date of purchase, owners name, email or Tel & Fax, address and purchaser vehicle details. Any products that COMEUP determines to be accountable for defective will be repaired or replaced or refund at COMEUP sole discretion without charge to buyer upon buyer's compliance with these procedures. In the event of repair or replace, purchaser must send the defective winch or part, with freight prepaid, to COMEUP or its authorized distributor. And COMEUP will send the serviced product back to purchaser on COMEUP's cost. This warranty does not cover the removal or reinstallation of the winch.

COMEUP takes the responsibility for COMEUP winch parts and components to be free from defects in materials and workmanship, but the following portions are hereby excluded and disclaimed. COMEUP or its authorized distributors may make reasonable charges for parts and labour for repairs or resumption in the following portions not covered by this limited warranty.

- (1). All warranties of wire rope and synthetic rope assemblies after initial use
- (2). All warranties of fitness for a particular purpose
- (3). All warranties of the product's finish
- (4). All warranties of merchantability

The limited warranty does not cover any failure that results from improper installation/operation, third party part substitution, purchaser's alteration or modification on COMEUP winch. This warranty is void when COMEUP serial number plate is removed or defaced.

COMEUP's liability to the purchaser under the winch purchases for any loss or damage howsoever and whatsoever arising shall not exceed the price of the initial winch purchase receipt. COMEUP shall not in any event be liable to the purchaser for any consequential and/or indirect loss or damage whether for loss or for profit or otherwise, costs, expenses or other claims for consequential compensation whatsoever and whether caused by negligence of COMEUP employees, distributors and their employees or otherwise. COMEUP reserves the right to change product design without notice. In situations in which COMEUP has changed a product design, COMEUP shall have no obligation to upgrade or otherwise modify previously manufactured products.

# COMEUP WINCH

## Utility Duty Winch

Thank you for purchasing a **COMEUP** Winch. This manual covers operation and maintenance of the winch. All information in this publication is based on the latest production information available at the time of printing. We reserve the right to make changes without notice because of continued product improvement.

The winch has been designed to give safe and dependable service if operated according to the instructions. Please read and understand this manual before installation and operation of the winch. Careless winch operation can result in serious injury or property damage.

When requesting information or ordering replacement parts, always give the following information:

1. Winch model and voltage
2. Serial Number
3. Item. No. and Part Number
4. Part Description



1. The winch is a very powerful machine. Treat with extreme care and observe all caution and warnings.
2. The winch is rated at the first layer of wire/synthetic rope on the drum for intermittent-periodic duty.
3. The winch is not to be used to lift, support or otherwise transport personnel.
4. A minimum of five (5) wraps of steel wire rope and of ten (10) wraps of synthetic rope around the drum is necessary to support the rated load.
5. Keep clear of winch, rope, hook, and fairlead while operating.
6. Wire/synthetic rope can break without warning. Always keep a safe distance from the winch and rope while under a load
7. Failure to adequately align, support, or attach the winch to a suitable mounting base could result in a loss of efficiency of performance or damage to the winch, wire rope and mounting channel.

## I. Safety Precaution

The winch is designed to give safe and dependable service of trouble-free operation. Please read and understand this Instruction Manual before installing your winch.

### ► **Precautions before using of winch are listing as follows:**

- ⚠ Confirm that the winch complies with the using conditions.
- ⚠ Because the maximum rope tensile force capable of loading decreases corresponding to the increase of number of winding layers, please carry out rope winding according to the instruction of this manual.
- ⚠ Don't use rope that is unsuitable because of its construction, strength or having any defects.
- ⚠ Don't use a hook or pulley block that is suited to the rope.

### ► **Precautions at the time of operation of winch are listing as follows:**

- ⚠ The operator of winch in some cases is required to hold qualifications according to applicable laws and ordinances.
- ⚠ Prior to starting of use, carry out the daily checking without fail.
- ⚠ During use five(5) wraps of wire rope and ten (10) synthetic rope must remain on the drum at all times. Even in the condition where the rope is feed out at most,
- ⚠ Do not use winch as a lifting device or a hoist for vertical lift (fig1).
- ⚠ Do not use winch to move people.
- ⚠ Do not exceed maximum line pull ratings shown. Do not shock load.
- ⚠ Keep hands clear of wire/synthetic rope.
- ⚠ Pull from an angle below 15 degree to straighten up the vehicle or boat (fig 2).
- ⚠ Run the engine during winching operations to keep battery charged.
- ⚠ Use leather gloves or a heavy rag when handling the wire rope.
- ⚠ Disconnect the remote switch from the winch when not in use.
- ⚠ When winching a heavy load, lay a heavy blanket over the wire/synthetic rope near the hook end.
- ⚠ Always operate your winch in an underwound orientation only (Fig 3).

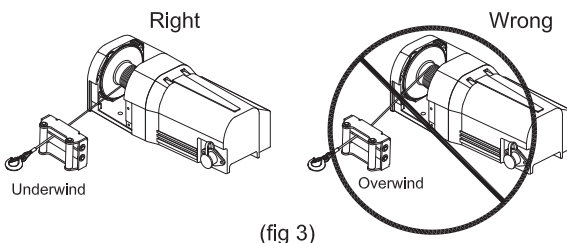
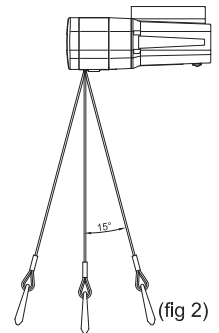
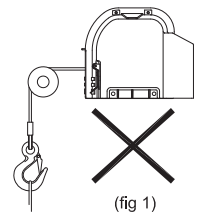

## II. Winching Principles

### ► Calculating Fleet Angle

To obtain the best wire/synthetic rope service, the direction of pull will be on a horizontal within  $\pm 15$  degrees and perpendicular to be centerline of the winch drum within  $\pm 5$  degrees. If the fleet angle is bigger than the recommended angles, a good spooling cannot be obtained as the rope will spoon onto one side of the rope drum and possible damage to the rope or winch.

### ► Load Rating

Load and speed varies according to how much wire/synthetic rope is on the drum. The first layer of rope on the drum delivers the slowest speed and the maximum load. A full drum delivers the maximum speed and the minimum load.

For this reason, all utility duty winches are rated at their first layer capacities.

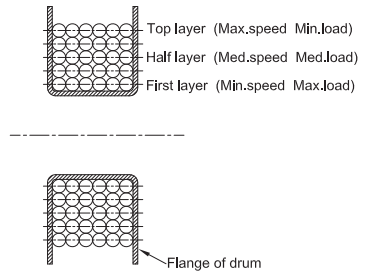

### ► Required Pulling Force

You need a winch powerful enough to overcome the weight of your vehicle with the added resistance caused by the obstacle, moving water, mud, snow, sand or on a steep hill.

As a general guide, you need a winch with a maximum line pull of at least 1.5 times greater than the gross vehicle weight.

There are three factors listed that influence the line pull effect required to recover the vehicle. The values and calculations in this section are approximate and are for reference only.

- a). Gross vehicle weight
- b). Type of the surface to be traversed
- c). Gradient to overcome

In recovery and loading the winch is used to pull something, the required pulling force (RPF) can be calculated according to the formula:

$$RPF = (Wt \times S) + (Wt \times G)$$

Where: Wt = The gross vehicle weight  
 S = The type of the surface to be traversed  
 G = The gradient to overcome

Surface Type	Surface Drag (S)
Metal	0.15
Sand	0.18
Gravel	0.20
Soft Sand	0.22
Mud	0.32
Marsh	0.52
Clay	0.52

Gradient	Angle ( $\theta$ )	Gradient (G)
5%	3°	0.06
10%	6°	0.11
20%	11°	0.2
30%	17°	0.3
50%	26°	0.44
70%	35°	0.58
100%	45°	0.71

For example, if a vehicle weighing 1,200 kg is winched up an incline by 100% on the marsh road, the above formula would be used as follows:

Where Wt: 1,200 kg, S: 0.52 G: 0.71

$$\begin{aligned} \text{RPF} &= (\text{Wt} \times \text{S}) + (\text{Wt} \times \text{G}) \\ &= (1,200 \text{ kg} \times 0.52) + (1,200 \text{ kg} \times 0.71) \\ &= 624 \text{ kg} + 852 \text{ kg} \\ &= 1,476 \text{ kg of effect required to recover the vehicle.} \end{aligned}$$

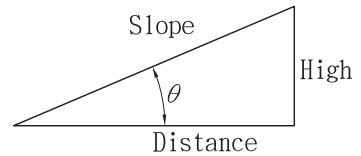

A slope of 10% is a rise of one meter in ten meters (High / Distance)

### ► Securing Anchor Point

When choosing an anchor point, select a safe and firm point such as a tree, stump or rocks. If using a winch to retrieve another vehicle, the rescue vehicle is considered the anchor point and should be made secure.

The anchor point must be strong enough to hold the gross weight of the vehicle and be positioned to keep the fleet angle between the centre of the anchor point and the wire/synthetic rope maintained less than 15°. Always use a tree trunk protector strap to prevent ring barking the tree and damaged to the wire rope.

### ► Winching V.S. Hoisting. A pulling winch should not be used for lifting.

Please refer to our website to view our full range of lifting winches.

## III. Accessories

### ► Roller Fairlead

The use of 4 ways roller fairlead can eliminate the contacting friction because the fairlead rollers contact with the wire/synthetic rope. But the fairlead does not insure the wire/synthetic rope will wind onto the drum in an orderly manner. The proper fleet angle within 15° must be maintained for the wire/synthetic rope to wind onto the drum in an orderly manner. If the proper fleet angle is not maintained, it can result in damage to the winch and wire/synthetic rope.

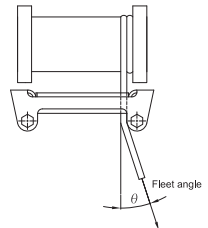

### ► Hawse Fairlead

The basic hawse fairlead is designed to guide the synthetic rope to and from the winch drum. Do not use cast steel hawse fairleads as they have sharp edges and they do not have enough radius for the rope to bend over.

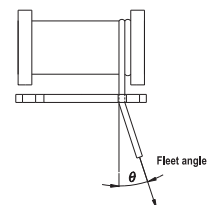

### ► Recovery Damper

A recovery damper is a safety device designed to help eliminated the possibility of injury or property damage in the event of a wire/synthetic rope failure. Place in the middle third of a live rope. The damper can help absorb the energy in the rope and reduce the likelihood of injury or damage.

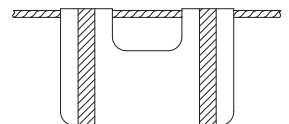

### ► Snatch Block

An important aid to successful winching is the use of snatch block, which can be used to increase the pulling power of a winch or change the direction of a pull.

A winch double lined with a snatch block creates a mechanical leverage cutting the effort required by nearly half.

The double line pull shows self recovery using a snatch block attached to an anchor point; the pull applied to the vehicle is almost twice as much as the line pull of the winch.

The use of one snatch block shows an indirect pull where the vehicle is limited due to unsuitable ground or obstruction. The pull on the load is the actual line pull of the winch. If more than one snatch block is used, they must be located at least 100 cm (40") apart.

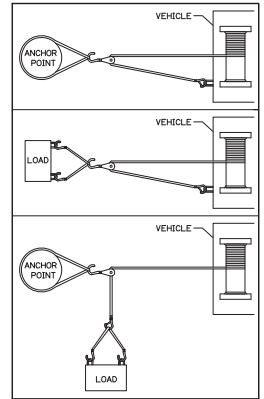

## IV. Installation

Before using the winch, make sure all electrical parts have no corrosion or damage; relative environment should be clear and dry.

The voltage drop from the point of supply to the load of machine must not exceed 10% of the nominal voltage under normal operating condition.

### ► Mounting

- 1). Use the mounting hardware (M10 bolt, nut and washer) to mount the winch on a flat surface (fig 5).
- 2). The motor, drum and gear housing must be properly aligned (fig 6).

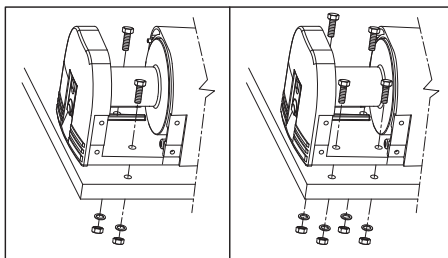

(Fig 5)

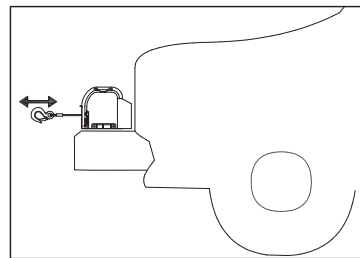

(Fig 6)



## ► Battery Leads Connection

1). Battery leads specification is listing as follows:

Model		DV-2500i	DV-3500i	DV-4500i	Utility winch 5000si
Control	Type	Solenoid/Indirect			Contactora/Indirect
Volt	12V	6 AWG × 5' (1.5 m)	6 AWG × 5' (1.5 m)	6 AWG × 5' (1.5 m)	6 AWG × 5' (1.5 m)
	24V	8 AWG × 5' (1.5 m)	8 AWG × 5' (1.5 m)	8 AWG × 5' (1.5 m)	X

- 2). Use a 5/16" bolt, nut and washer to attach the black lead (negative -) firmly to the base plate of the vehicle (fig 7).
- 3). Attach the red lead (positive +) tightly to the circuit breaker marked AUX, meanwhile, connect copper plate to the other end of the circuit breaker, marked BAT (fig 8).
- 4). Connect the copper plate to the connector of battery (fig 8).

## ► Switch Connection:

- 1). A hand-held remote switch w /1.25mm<sup>2</sup> x 3C x 3 m cord supplied.
- 2). Open the rubber gland of the winch, then insert the switch plug into the socket of the winch (fig 9).

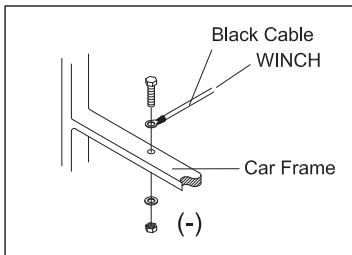

(Fig 7)

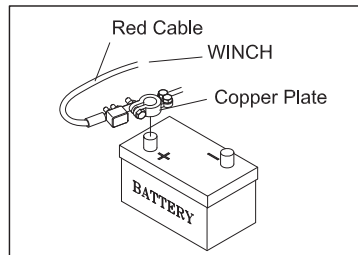

(Fig 8)

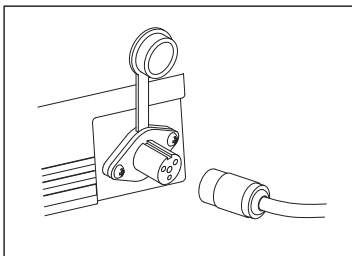

(Fig 9)

## V. Operation

### ►Precaution

- ⚠ Be sure to check all safety and environmental conditions.
- ⚠ A wire/synthetic rope should be discarded and not to be used again if rope shows sign of excessive wear too many broken wires, corrosion or other defects.
- ⚠ The operator of winch must remain with the winch at all times whilst the unit is being operated.
- ⚠ The type of duty is intermittent-periodic duty S3 and the load time never exceeds 2 minutes.
- ⚠ If a winch fails in pulling a load at a normal condition, stop the operation within 30 seconds, otherwise you will damage the motor.
- ⚠ Ensure that only the rated voltage is applied to the winch (ie. 12VDC or 24VDC).
- ⚠ Do not wrap the wire/synthetic rope around load and hook it to itself. Always use a strap to insure that the wire/synthetic rope does not fray or kink.
- ⚠ Keep hands and clothes away from the drum area, wire/synthetic rope and roller fairlead.
- ⚠ Never unplug the remote control when winching a load.
- ⚠ Determine that the winch is operating correctly before use.
- ⚠ To avoid insufficient power in pulling a load, the vehicle should be running and in neutral. The handbrake should be also on.
- ⚠ If noise or vibration occur while running, stop the winch immediately and send it for repaired. Don't use it again before trouble shooting completely.
- ⚠ If the winch is not to be used for a long time, we recommend disconnecting the battery lead from winch.

### ►Cable-in/ Cable-out Operation

- 1). To determine "Cable - Out", depress ↓ button (fig. 10)
- 2). To determine "Cable - In" depress ↑ button (fig.11)
- 3). To stop winching, release the button

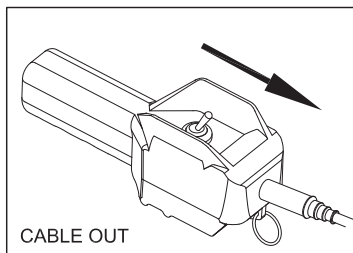

(Fig 10)

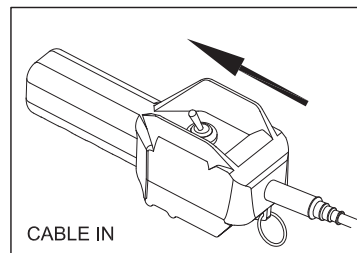

(Fig 11)

## ► Pairing the wireless remote control: (for Utility winch 5000si)

Your wireless remote control is already paired to your winch.

You can follow the below procedures for pairing your new wireless remote transmitter.

- 1). Press the cutout switch button to activate the winch operation. Verify a red light appears around the button. Wireless receiver icon blinking for 1 minute.
- 2). Press and hold the power button for about 5 seconds, the LED indicator illuminates green permanently.
- 3). Press either cable in button or cable out button for 1 second for pairing.
- 4). If pairing was successful, the wireless receiver icon will go off, and it is ready to operate.

## ► Take out the wireless remote transmitter

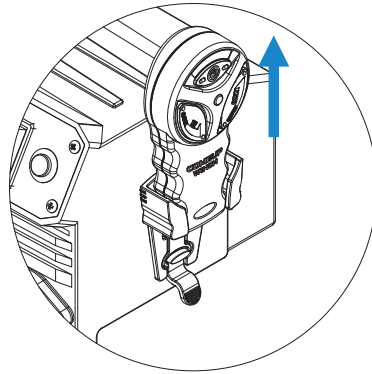
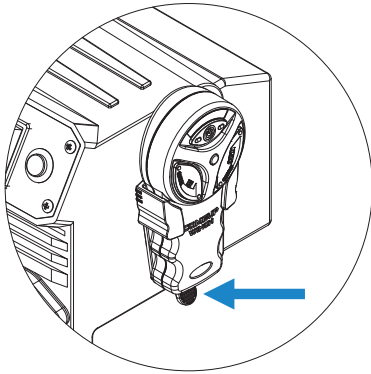

1). Press the button and release the transmitter.

2). Pull it up.

### 1. Wireless Control Module :

- 1.1. Press and hold the cable in button of the transmitter for rope winding in operation.
- 1.2. Press and hold the cable out button of the transmitter for rope winding out operation.
- 1.3. Stop winching, release the cable in or cable out buttons.

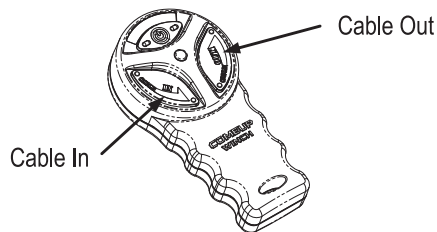

### 2. Additional Emergency Stop Function:

The power button also works as an emergency stop if the radio control is in malfunction of any reason. While the radio control is in operation (either winch in or winch out, the red light is on), once power button is pressed, the radio control will be forced to power off immediately. Winch will stop running accordingly.

## ► Power on the winch (Getting started): (for Utility winch 5000si)

1). Turn on / off:

1.1 Press the cutout switch to start up the winch, and verify a red light appears around the button.

1.2 The wireless receiver icon is blinking.

1.3 Vehicle battery life icon will light on

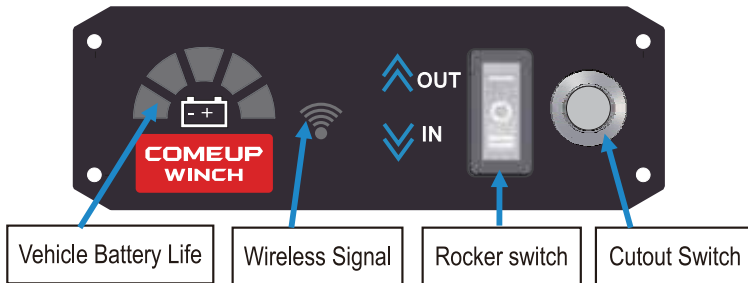

2). Rocker Switch:

Directly control winch in and out.

3). Wireless Transmitter :

Your Utility winch 5000si can be operated by wireless remote control.

Press and hold the power button for 5 seconds to activate winch operation. The green LED Indicator lights up.

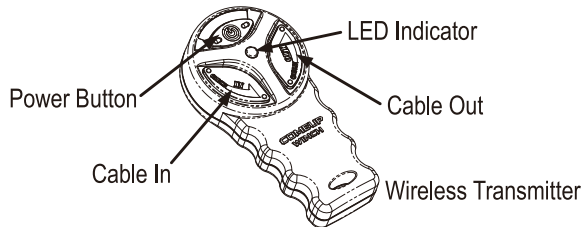

### 1.2 Battery replacement

When the green LED Indicator is flashing indicates an extreme low battery level of wireless transmitter's. The battery should be replaced.

a). Loosen the three screws from the back cover of the wireless transmitter



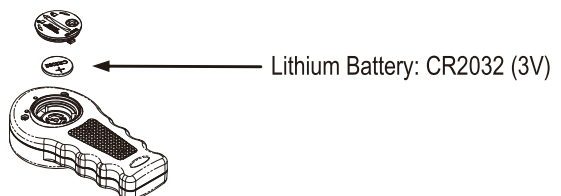

b). Separate the top section and remove the old battery and dispose it.

c). Insert new 3V lithium battery and join the top section with the bottom section.

d). Make sure to fasten the three screws.



► **Wireless remote control module : (for Utility winch 5000si)**

Applicable models	Utility winch 5000si			
LED				
				Transmitter LED
Turn on	on	on	Blinking	X
Press Transmitter for 5 seconds				Turn on Green
Programming			off	
If programming failed , Winch will automatically use the previous programming after 1 minute.				
Cable in/out	on	on	on	Red
No operation			off	Green
Low voltage on transmitter			Blinking	Blinking Green
Poor signal warning			Blinking	Blinking Red
Press the power button for 5 seconds to turn transmitter off.		off	off	off
Press the power button to turn winch off.	off	X	X	X

1. Cutout Switch :

Your Utility winch 5000si has a cutout switch, it is to activate or deactivate the winch.

The cutout switch could also cut out the battery draw of wireless control models when the engine is not running.

2. Vehicle Battery Level :

The dash board of your Utility winch 5000si is with battery indicator to show the status of vehicle battery level.

1st Icon (Green): Fully charged around 12V level

2nd Icon (Green): Fair charged around 11V

3rd Icon (Green): Fair charged around 10 V

4th Icon (Green): Low charged around 9V

5th Icon (Blinking Red): Extreme low below 8V

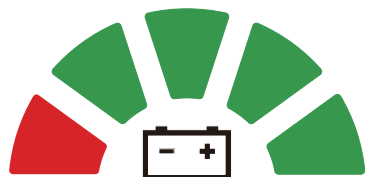



### ► **Wireless Receiver & Transmitter Operation**

This wireless remote control device complies with CE mark, FCC and Industry Canada (IC) rules.

#### **CE Mark Warning**

- This is a Class B product, in a domestic environment, this product may cause radio interference, In which case the user may be required to take adequate measures.

### **FEDERAL COMMUNICATIONS COMMISSION INTERFERENCE STATEMENT**

This equipment has been tested and found to comply with the limits for a Class B digital device, pursuant to part 15 of the FCC Rules. These limits are designed to provide reasonable protection against harmful interference in a residential installation. This equipment generates, uses and can radiate radio frequency energy and, if not installed and used in accordance with the instructions, may cause harmful interference to radio communications. However, there is no guarantee that interference will not occur in a particular installation. If this equipment does cause harmful interference to radio or television reception, which can be determined by turning the equipment off and on, the user is encouraged to try to correct the interference by one or more of the following measures:

- Reorient or relocate the receiving antenna.
- Increase the separation between the equipment and receiver.
- Connect the equipment into an outlet on a circuit different from that to which the receiver is connected.
- Consult the dealer or an experienced radio/ TV technician for help.

#### **CAUTION:**

Any changes or modifications not expressly approved by the grantee of this device could void the user's authority to operate the equipment.

#### **RF exposure warning**

The equipment complies with FCC RF exposure limits set forth for an uncontrolled environment. The equipment must not be co-located or operating in conjunction with any other antenna or transmitter.

## ► Clutch Function

The free-spool allows rapid wire/synthetic rope payout for hooking onto the load or anchor points and is operated by a free-spool level.

The free-spool level must be in the “Engaged” position before winching (fig 12)

- 1).To disengage the free-spool by lifting a free-spool lever in the “Disengaged” position, wire rope can now be free spooled on the drum (fig13)
- 2).To engaged the free-spool, press a free-spool level in the “Engaged” position.
- 3).If a free-spool lever can't be properly locked in the “Disengaged” position, rotate the drum to make the pole free-spool to couple the gear train completely.
- 4).Wear leather gloves and use a handsaver strap when guiding the wire rope out of the drum.

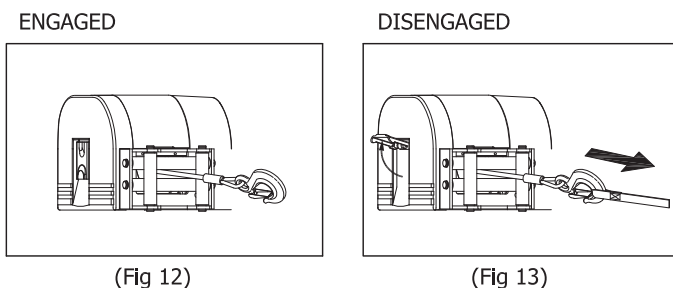

(Fig 12)

(Fig 13)

## ► Use a Snatch Block Assembly

The proper usage of snatch block will nearly double the capacity of the winch but the speed will decay 50%.

It is recommended to use snatch block for loading over the rated load.

When a snatch block is applied, be sure that the anchor point of the hook is secured to withstand the double line rated capacity of the winch.

## VI. Maintenance

### ► Lubrication

All moving parts in the winch are permanently lubricated at the time of assembly. Under normal conditions factory lubrication will suffice. If re-lubrication is necessary after repair or disassembly only use marine type grease.

### ► Wire Rope Replacement

Never substitute a heavier or lighter rope. Never use rope made of any material other than wire.

- 1).Spool the entire wire rope, then cut and take it out from the drum.
- 2).Put the replacement wire rope through the fairlead opening, pass below the drum, and insert it into the hole of drum core.
- 3).Tighten the screw downwards to secure the wire rope (fig14).

- 4).Secure the wire rope to the hook with 2 sets of cable clip, tighten the screw completely (fig 15).

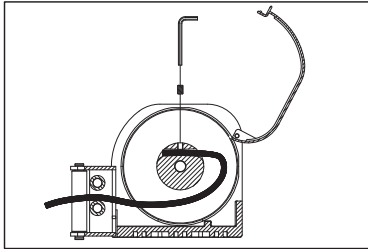

(Fig 14)

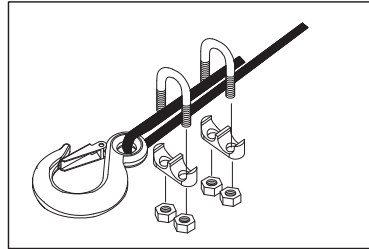

(Fig 15)

### ► Synthetic Rope Replacement

Do not wind out past the red paint section of the rope to secure the rope anchorage on the drum.

- 1). Disengage the clutch shift, remove existing rope and replace hawse if necessary.
- 2). Remove the set-screw on the drum and spool out the rope from the drum.
- 3). Cut the lateral side of the end by 45° and apply 2-3 wraps of electrical tape to hold cut strands in place
- 4). Thread rope through a roller fairlead and under the drum, insert the rope through the hole on the drum with 6 – 7 cm / 2.4" – 2.8".
- 5). Place rope across the drum and tape the end down to hold it in place. Lightly tighten the set-screw to squeeze the rope, do not over tighten.
- 6). A minimum of ten (10) wraps of rope around the drum is necessary to support the rated load.

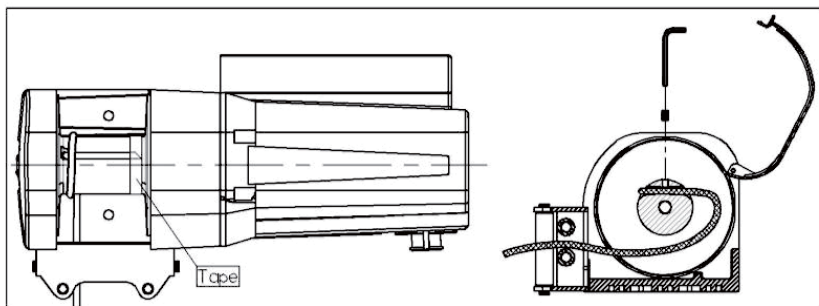

### ► Tip for prolonging the life of Synthetic rope

- 1.Regular maintenance and periodically check the rope for damage or wear
- 2.Since too much abrasion can damage or weaken your synthetic rope, protect your rope from rubbing against sharp objects or edge
- 3.Keeping your synthetic rope clean and dry. To clean it after a muddy ride, spool out the rope, rinse it with a hose, and let it dry completely before re-spooling



► Maintenance Schedule

Classification of check			Item	Checking method	Checking reference	
Daily	Periodical					
	Monthly	Quarterly				
○			Installation	Mounting bolts & alignment	Bolt tension & wear	Existence of abnormalities
○			Remote control	Working	Manual	Reasonable actuation
		○		Wearing in contact points	Visual	Free of wear or damage
○			Wire rope	Broken strands	Visual,	Less than 10%
○	○			Decrease in rope diameter	measuring Visual, measuring	7% of nominal diameter max
○				Fastening condition of end	Visual	Existence of abnormalities
○				Deforming or corrosion	Visual	Existence of abnormalities
○			Synthetic rope	Broken strands	Visual, measuring	Two or more adjacent strands are cut
○	○			Decrease in rope diameter	Visual, measuring	25% of nominal diameter max
○				Fused or melted fibers	Visual	Existence of abnormalities
○				Fastening condition of end	Visual	Existence of abnormalities
		○	Clutch assembly	Damaged clutch assembly	Visual evidence of wear	Free of wear or damage
		○	Motor	Staining, damage	Visual evidence of wear	Existence of abnormalities
		○	Brake	Wearing of brake disc	Visual evidence of wear	Free of wear or damage
○				Performance	Visual	Reasonable actuation
		○	Gear	Damage, wearing	Visual evidence of wear	Free of wear or damage

If the winch fails to operate after several attempt, or if there is any fault whilst operation:

Symptom	Possible Cause	Remedy
Winch will not operate	Cut circuit	Check battery lead
	Weak battery	Recharge or replace battery, 650CCA
	Damaged circuit breaker	Replace circuit breaker
	Bad connection of wiring	Reconnect tightly
	Damaged DC solenoid	Replace DC solenoid
	Cut circuit on switch	Replace switch
	Damaged motor or carbon brush.	Replace motor or carbon brush
	Poor or lost connections to motor	Replace wiring or tighten it
Motor runs in one direction.	Broken wiring or bad connections	Reconnect or replace wiring
	Damaged or stuck DC solenoid	Replace DC solenoid
	Switch inoperative	Replace switch
Drum will not clutch.	Clutch does not disengage	Replace clutch
	Damaged 1 <sup>st</sup> shaft	Replace 1 <sup>st</sup> shaft
	Damaged brake cam and disc	Replace brake cam and disc
	Damaged output shaft	Replace output shaft
No brake	The gear train is mechanically binding up	Check to insure the winch is mounted on a flat, rigid surface
	Damaged brake cam and disc	Replace brake cam and disc
	Damaged gear box	Replace gear box
	Broken retaining ring	Replace retaining ring
	Oil leakage into brake cavity	Repair and clean oil leakage
Brake distance is too long	Damaged or inoperative spiral spring	Replace and position spiral spring
	Worn brake disc or loose brake spacer	Replace brake disc or adjust brake spacer according to brake adjustment procedures
Brake will be locked	Oil leakage into brake cavity	Repair and clean oil leakage
	Too much brake disc powder in the brake hub	Clean brake hub
	Over tensioned spiral spring	Adjust tension on spiral spring
Damaged gear box	Stuck between brake disc and gear box	Replace with new brake assembly
	Hit by certain exterior force	Replace the damaged components
	Damaged gear train	Replace the damaged components
Motor runs extremely hot	Over load operation	Stop the winch operation and reduce the load
	Long period of operation	Allow to cool
	Damaged motor	Replace or repair motor
	Damaged or inoperative brake	Replace or repair brake



**COMEUP  
WINCH**

**COMEUP INDUSTRIES INC.**

No.139, Jieyukeng Rd., Ruifang Dist.,  
New Taipei City 22453, Taiwan

Tel: +886-2-24971788

Fax: +886-2-24971699

Email: [info@comeup.com.tw](mailto:info@comeup.com.tw)

[www.comeupwinch.com](http://www.comeupwinch.com)



PN 882365 Ver:06

Specifications subject to change without notice.