

COMEUP WINCH

HEAVY DUTY HOIST

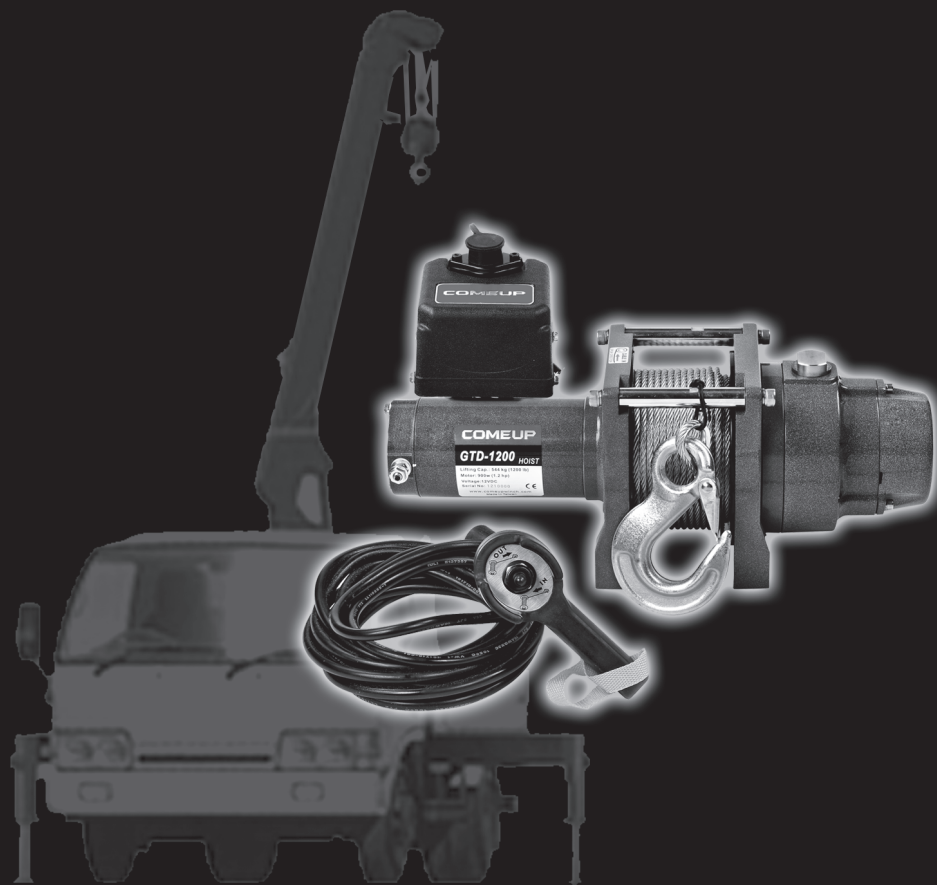

INSTRUCTION MANUAL





Heavy Duty Hoist

Limited One (1) Year Warranty

WARRANTY

Comeup Industries Inc. (**COMEUP**) warrants to the original purchaser that **COMEUP** heavy duty hoist will be free of defects in material and workmanship for a period of one (1) year from the original date of purchase. All mounting kits and other accessories carry a one (1) year limited warranty against defects in material workmanship.

This warranty applies only to the original purchaser of the hoist. To obtain any warranty service, the purchaser under this Limited Warranty is requested to advise **COMEUP** or its authorized distributors on any claim. The purchaser must provide a copy of the purchase receipt bearing the hoist serial number, date of purchase, owners name, email or Tel & Fax, address and purchaser vehicle details. Any products that **COMEUP** determines to be accountable for defective will be repaired or replaced or refund at **COMEUP** sole discretion without charge to buyer upon buyer's compliance with these procedures. In the event of repair or replace, purchaser must send the defective hoist or part, with freight prepaid, to **COMEUP** or its authorized distributor. And **COMEUP** will send the serviced product back to purchaser on **COMEUP**'s cost. This warranty does not cover the removal or reinstallation of the hoist.

COMEUP takes the responsibility for **COMEUP** hoist parts and components to be free from defects in materials and workmanship, but the following portions are hereby excluded and disclaimed. **COMEUP** or its authorized distributors may make reasonable charges for parts and labour for repairs or resumption in the following portions not covered by this limited warranty.

- (1). All warranties of wire rope assembly after initial use
- (2). All warranties of fitness for a particular purpose
- (3). All warranties of the product's finish
- (4). All warranties of merchantability

The limited warranty does not cover any failure that results from improper installation/operation, third party part substitution, purchaser's alteration or modification on **COMEUP** hoist. This warranty is void when **COMEUP** serial number plate is removed or defaced.

COMEUP's liability to the purchaser under the hoist purchases for any loss or damage howsoever and whatsoever arising shall not exceed the price of the initial hoist purchase receipt. **COMEUP** shall not in any event be liable to the purchaser for any consequential and/or indirect loss or damage whether for loss or for profit or otherwise, costs, expenses or other claims for consequential compensation whatsoever and whether caused by negligence of employees, distributors and their employees or otherwise. **COMEUP** reserves the right to change product design without notice. In situations in which **COMEUP** has changed a product design, **COMEUP** shall have no obligation to upgrade or otherwise modify previously manufactured products.

Thank you for purchasing a **COMEUP** Hoist. This manual covers operation and maintenance of the hoist. All information in this publication is based on the latest production information available at the time of printing. We reserve the right to make changes without notice because of continued product improvement.

It has been designed to give safe and dependable service if operated according to the instructions. Read and understand this manual before installation and operation of hoist. Careless hoist operation can result in serious injury or property damage.

When requesting information or ordering replacement parts, always give the following information:



1. Hoist model and voltage
2. Serial Number
3. Item. No. and Part Number
4. Part Description





















WARNING

1. The hoist is rated at its top layer of wire rope on the drum for S3 Intermittent duty.
2. A minimum of five (5) wraps of rope around the drum is necessary to support the rated load.
3. Keep clear of hoist, rope, and hook while operating.
4. Wire rope can break without warning. Always keep a safe distance from the hoist and rope while under a load.
5. Failure to adequately align, support, or attach hoist to a suitable mounting base could result in a loss of efficiency of performance or damage the hoist, rope and mounting channel.
6. The hoist is a very powerful machine. Treat with extreme care and observe all caution and warnings.

I. Safety Requirement

 WARNING	
	<ol style="list-style-type: none">1. The owner and/or the operator shall have an understanding of these operating instructions and the warning before operating the electrical hoist. Failure to follow these warnings may result in loss of load, damage to the hoist, property damage, personal, or fatal injury.2. The owner shall retain this manual for further reference to important warnings, installation, operating and maintenance instructions.

► **General Rules**

-  The operator of a hoist in some cases is required to have qualifications according to applicable laws and ordinances.
-  Check all safety and environmental conditions prior to and during use.
-  Don't use unsuitable rope in construction, strength or having any defects.
-  Don't use an unsuitable hook and snatch block for rope.
-  The operator must remain with the hoist when it is being operated.
-  The hoist is rated at S3 25% Intermittent duty only.
-  Do not use the hoist as moving people.
-  Ensure that the hoist is connected to the correct voltage. 12V DC or 24V DC only.
-  Do not exceed maximum lifting load shown in tables. Shock load must not exceed these ratings.
-  A rope should be replaced if it shows signs of excessive wear, broken strands, corrosion or any other defects.
-  If the hoist fails to lift a load under normal conditions, stop the operation within 30 seconds otherwise motor damage may occur.
-  Remove the switch from the hoist when not in use.
-  Keep hands and clothes away from the hoist and rope.
-  Never unplug the remote control when hoisting a load.
-  To avoid insufficient power when hoisting a load, the vehicle should be running and in neutral.
-  If noise or vibration occurs when running, stop the hoist immediately and return it for repair.
-  The rope shall be wound in according to drum rotation sticker or refer to owners manual, otherwise, the brake will not function.
-  Ensure to use the insulating boots on the exposed connections to offer better insulations and to prevent electrical shorting.

II. Handling Precautions

► Operation Precaution

- * To prevent the risk of electric shock, the power plug must be plugged into a matching outlet and grounded in good condition.
- * Never try to lift a load higher than the rated cap.
- * Never hitch a ride on the hook, sling or load being moving.
- * Hoists are not to be used for lifting or lowering people.
- * Don't work, walk or stand under an operating hoist.
- * Always remain in control. Never neglect the hoist while actually hosting a load.
- * While working, never stand under a lifting load or within the conveying area.
- * Always look up when working around hoist, there is potential danger overhead.
- * Never gravitate a load free.
- * Be sure to lift a load vertically. Slack may allow wires to be caught in the drum.
- * Prior to starting of use, carry out the daily checking without fail, and after confirming the safety of function.
- * If having a counter rotation incurred, make sure to correct its rotation direction.
- * Prior to lift, make sure to have a precise performance of brake. If any malfunction of brake happened, stop the operation immediately.
- * When load suspended in air, it will not allow to be welding.
- * Wire rope with one or more of the following defects shall be removed or replaced immediately.
 - 1) kink, 2) distortion, 3) corrosion.
 - 4) showing sings of excessive wear or of having broken wires not less than 10 pcs.
- * Stop the operation if there is any queer noise or vibration in the gear box to be happened.
- * Do not connect the wire rope with the grounding of welding machine.
- * While welding, do not have any contact with the welding objects because of having spark.
- * Do not pull the switch.
- * Never plugging (instant reverse-wind) or inching.
- * Do not over duty cycle ratings.
- * In order to prevent the layer down due to over loosening of rope irregular winding, etc., operate according to the suitable operating method.
- * Use a hoist by fixing so securely that the rope around the drum is even.
- * Be sure to fix a rope in the centre of swivel hook.
- * Be sure to stop operation immediately when the wire rope becomes fully slackened.
- * Avoid catching the hook or lifting a load on a fixed obstruction.
- * Always leave the remote switch positioned immediately after use.
- * Make sure that the load being lifting are well balanced and secured before starting.
- * Avoid water splashes on the remote switch.
- * Never wrap the load with the wire rope.

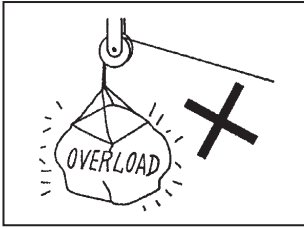

- It is forbidden to lift loads above the rated capacity of the hoist

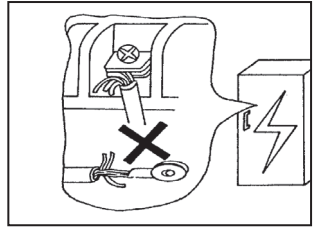

- Do not connect the power lead on the main power source directly and fasten them

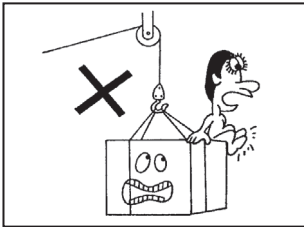

- Ban on transporting persons

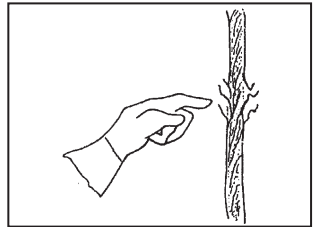

- Don't ignore fault accessories

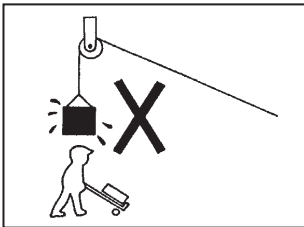

- Don't stand under hoisting operation

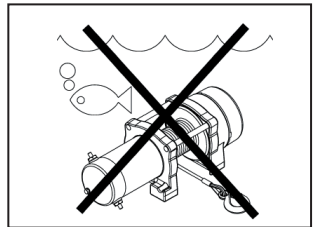

- Never submerge winch in water as winch rated at IP44.

III. Environment Precautions



DANGER



The following environmental conditions may result in the possible causes of hoist trouble.

- Low temperature below -10°C , high temperature above 40°C or humidity above 90% conditions.

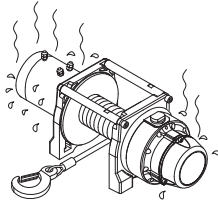

- ※ Cause malfunction of spare parts

- In an organic chemistry or explosive powder condition.

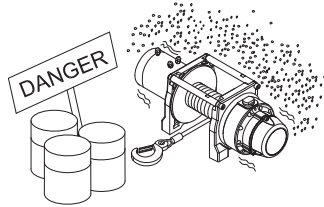

- ※ Cause explosion

- In the rain or snow conditions.

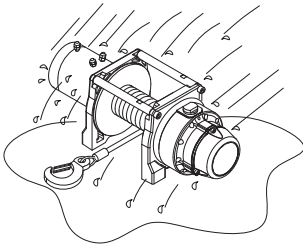

- ※ Cause malfunction of spare parts.

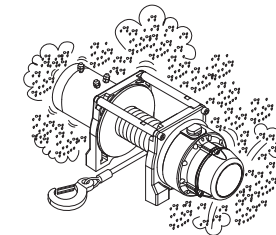

- ※ Cause malfunction of performances.

IV. Hoisting Principles

► Load Rated

Load and speed varies according to how much wire rope is on the drum. The first layer of rope on the drum delivers the slowest speed and the maximum load. The top layer of rope on the drum delivers the maximum speed and the minimum load. For this reason, all hoists are rated at their top layer capacities.

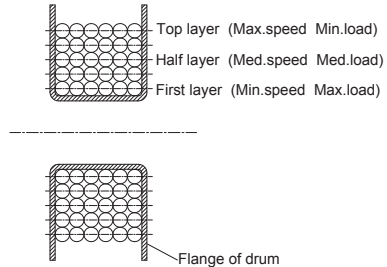

The flanged drum end plates shall protrude beyond the rope wound on the drum at the top layer by at least 1.5 x the nominal rope diameter.

► Calculating Head Loads

P: Rope tension
 η : Sheave efficient
 θ : Angle
 W: Load
 μ : Friction factor

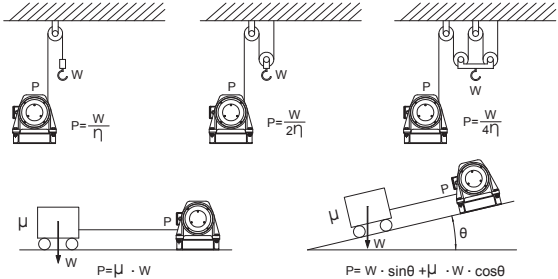

No. of sheaves	1	2
Roller bearing	0.98	0.96
Sleeve bearing	0.96	0.92

► Calculating Fleet Angle

- The hoist should be mounted as close to centre and as perpendicular as possible to the direction of the line pull. This will keep the wire rope fleet angle centred on the drum as small as possible.
- If the proper fleet angle is not maintained, the wire rope could wind onto one side of the drum.

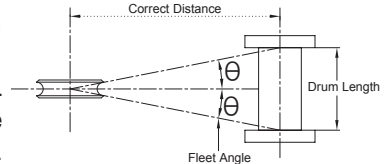

This could cause failure of the hoist or wire rope, resulting in damage, injury or death.

- Experience has shown that the best wire rope service is obtained when the maximum fleet angle is not more than 1.5° for smooth drums.
- Therefore the correct distance between centre of drum and of should be derived as a fleet angle of 1.5° is the equivalents of approximately 19 cm of lead for each centimetre of overall drum length.

Model	GTD-650	GTD-800	GTD-1200	GTD-2200	GTD-2800
Drum Length	61.2 mm	68 mm	89 mm	108 mm	135 mm
Correct Distance	1.16 m at least	1.29 m at least	1.69 m at least	2.05 m at least	2.57 m at least

► Percentage Duty Cycle

 WARNING	
	Never hoist over the rated percentage duty cycle.

The life of the hoist is depending on the conditions of the load and working frequency.

In the long time operation, make sure to use the machine within its %ED ratings.

Continuous ratings means the percentage duty cycle (%ED) is subject to the rated voltage and a 63% of rated load.

$$\text{Percentage duty cycle (\%ED)} = \frac{T_b}{T_b + T_s} \times 100 (\%)$$

T_b: total sum of overall loadings operating hours.

T_s: total sum of stopping hours.

T_b + T_s = approximately 1 to 10 minutes.

The duty cycle of heavy duty hoist varies according to the rated lifting.

Rated lifting kg / lb	GTD-650 min / 10 min		GTD-800 min / 10 min		GTD-1200 min / 10 min		GTD-2200 min / 10 min		GTD-2800 min / 10 min	
	12V	24V	12V	24V	12V	24V	12V	24V	12V	24V
No load	3.0	3.0	2.5	Cont.	Cont.					
147 / 320	2.0	—	2.3	—	—	—	—	—	—	—
181 / 400	—	2.0	—	Cont.	8.0	—	—	—	—	—
227 / 500	—	—	—	—	—	9.0	7.0			
272 / 600	1.5	—	2.0	—	—	—	—	—	—	—
362 / 800	—	1.5	—	8.0	6.0	—	—			
408 / 900	—	—	1.8	—	—	—	—	—	—	—
454 / 1000	—	—	—	—	—	7.0	4.5			
544 / 1,200	—	—	1.5	6.0	4.0	—	—			
771 / 1,700	—	—	—	4.5	3.0	5.0	3.0			
998 / 2,200	—	—	—	3.0	2.0	3.5	2.5			
1,270 / 2,800	—	—	—	—	—	2.5	2.0			

► D/d Ratio

The drum diameter to wire rope diameter ratio (D/d) determines the wire rope size required.

Minimum hoist drum root diameter = wire rope diameter x ANSI B30.5* ratio minus rope diameter.

The greater the ratio the longer the wire rope life.

* In compliance with standard of ANSI B 30.5, the rope safety factory shall maintain at least 18:1

► **Rope Safety Factor**

The working coefficient shall be determined from the ratio of the minimum breaking force of the rope and the maximum possible lifting force.

* In compliance with standard of ANSI B 30.5, the rope safety factory shall maintain at least 3.5:1

► **Standard compliance of EC Directives**

The EC directive includes the following individual directives

• **Machinery Directive 2006/42/EC**

It applies to independently functional machinery or the interlinking machines to form entire systems. The complete machine and plant must always fulfill the directive.

• **Electromagnetic Compatibility Directive (EMC) 2004/108/EC**

It applies to most electrical and electronic apparatus, that is, finished products and systems that include electrical and electronic equipment to ensure that the electromagnetic disturbance generated by apparatus does not exceed a level allowing radio and telecommunications equipment and other apparatus to operate as intended, and that apparatus has an adequate level of intrinsic immunity to electromagnetic disturbance to enable it to operate as intended.

► **Extracts from the EC Directive & Comeup compliance:**

1. EN 14492-1 Section 5.15.6 Wire Rope

Wire rope minimum break to be twice hoist rating

2. EN 14492-1 Section 5.7.2 Rope Drum

Rope drum mean diameter to be 10 times the diameter of the wire rope

3. EN 14492-1 Section 5.7.6 Rope Fastening onto the rope drum

Rope attachment to withstand 2.5 times the hoist rating

Rope must have at least two wraps winding before fixing point

4. EN 14492-1 Section 5.15.5 Brake

Hoist to hold full rated load

5. EN 14492-1 Section 5.15.2 Rated Capacity Limiters

The thermal overload cutout limit the driving power of the motor prevents hoist overloading

► **To comply with EN 14492-1, the following optional accessories must be fitted to all hoists**

- Overload protection device
- Emergency stop kit
- Up and Down limits protection device
- Rope drum cover
- Battery isolator switch

When using and installing a hoist, the owner or end user shall ensure that all legal requirements are completely complied with.

V. Operation

► Electrical Wiring Diagram

Before using the hoist, make sure all electrical components have no corrosion or damaged; the environment should be clean and dry. The voltage drop from the battery connections to the hoist must not exceed 10% of the nominal voltage under normal operating condition.

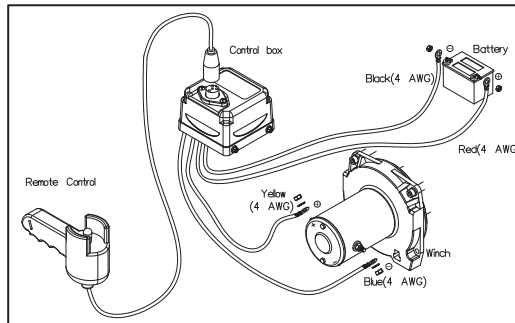

► Switch Connection

1. A remote switch with 1.25 mm (diameter) X 3C X 5 m (16AWG X 3C X 17ft) cord supplied.
2. Open the dust-proof cover of the hoist and then insert the switch plug into the socket.

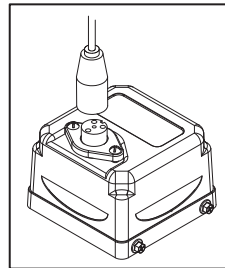

► Battery Recommendations

A fully charged battery and good connections are essential for the proper operation of your hoist. The minimum requirement for battery is 650 cold cranking amp.

► Cable-in / Cable-out Operation

1. To determine "Cable - Out", trigger → out
2. To determine "Cable - In", trigger ← in
3. To stop hoist, release the trigger

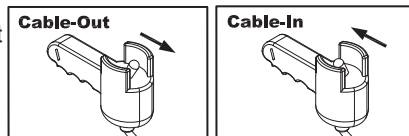

► Lubrication

All moving parts in the hoist are permanently lubricated at the time of assembly. Under normal conditions factory lubrication will suffice. If re-lubrication is necessary after repair or disassembly use marine type grease.

VI. Maintenance

► Tip for prolonging the life of wire rope

- 1). Do not wind out past the red paint section of the rope to secure the anchorage of the rope on the drum.
- 2). Make sure the first layer of wire rope is tight and maintain a freeboard at least 1.5 x rope diameter on the drum
- 3). To compensate for uneven spooling and the decrease in line pull capacity as the drum fills up, use as short a wire rope as practical.
- 4). A minimum of five wraps of rope around the drum load is necessary to support the rated load.

► Wire Rope Replacement

For GTD-650/800/1200

Before installing a new wire/synthetic rope, wrap the end of the wire rope with tape to prevent fraying. Wind the wire rope on the drum by pulling a force to keep the tension constant. Never use a wire/synthetic rope of a different size or material.

- 1). Spool the old wire rope, and then remove it from the drum.
- 2). Pass it below the drum. Insert rope into pocket opening and through wedge pocket.
- 3). Loop rope end around wedge and feed rope back through wedge pocket.
- 4). Once slack is taken up, the wire rope is properly installed.
- 5). Tighten the horizontal roller of the roller fairlead and bolts of the roller/hawse fairlead
- 6). Wear leather gloves and use a strap when guiding the wire/synthetic rope off the drum.
- 7). Rewind wire/synthetic rope on the drum correctly, it is necessary to keep a slight load on the wire/ rope while cable in.

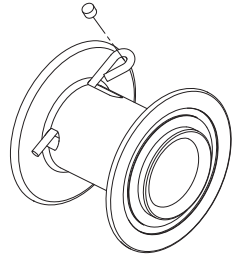

For GTD-2200/2800

- 1). Feed the end of the wire rope into No. 1 anchor hole in the drum and wind about 1/4 wrap of rope on the drum. Insert the wire rope into No. 2 hole and tighten the set screw securely.
- 2). Make sure the first layer of wire rope is tight and maintain a freeboard at least 1.5 x rope diameter.
- 3). Wire rope shall be wound in an under-wound orientation only.
- 4). To compensate for uneven spooling and the decrease in line pull capacity as the drum fills up, use as short a wire rope as practical.

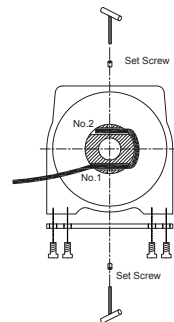

► Brake Kit Replace

Under normal operation, there is no need to adjust the brake mechanism. When the brake fails to hold a load within the distance 1.5% of line speed, please follow steps below to replace the brake kit:

For GTD-650/800

- 1). Loosen the 3pcs M6 screws on motor support rack, and depart the motor support rack from the drum.
- 2). Take off C-type retaining ring(R25) with a C clip, and take out coupler A, coupler B, and brake spring.
- 3). Insert new coupler A, brake spring, coupler B, and C-type retaining ring(R25) in order.
- 4). Make sure the brake spring is inserted in correct direction, the upper feet of brake spring need to fit in the notch of coupler A.
- 5). Make sure the notch of coupler B is toward down, and the lower feet of brake spring can fit in the notch while rotating the coupler B.
- 6). Insert the C-type retaining ring (R25) with a C clip.
- 7). Assemble motor support rack and drum with 3pcs of M6 screws.

For GTD-1200/2200/2800

- 1). Loosen and take off the bolts on the brake cover to remove the brake cover.
- 2). After the brake clutch base is removed, take off 2 C-type retaining rings with a C clip, then replace the brake kit and wave washer.
- 3). Insert new brake kit, have the foot of volute spring inserted into the pin hole of the brake kit.
- 4). Check the brake gap and insert spacers to maintain the brake gap to be:
2.0~1.5 for GTD-1200.
 2.2 ± 0.25 mm for GTD-2200/2800.
- 5). Insert the block A, rotate it counter-clockwise by around 140 degree for GTD-1200 and 150 degree for GTD-2200/2800; install spacer and 2 C-type retaining rings.
- 6). Install the brake clutch base and brake cover in order.
- 7). To avoid impacting the brake function, please remember to install the enclosed wave washers while replacing the brake clutch base.

For GTD-650/800

For GTD-1200

For GTD-2200/2800

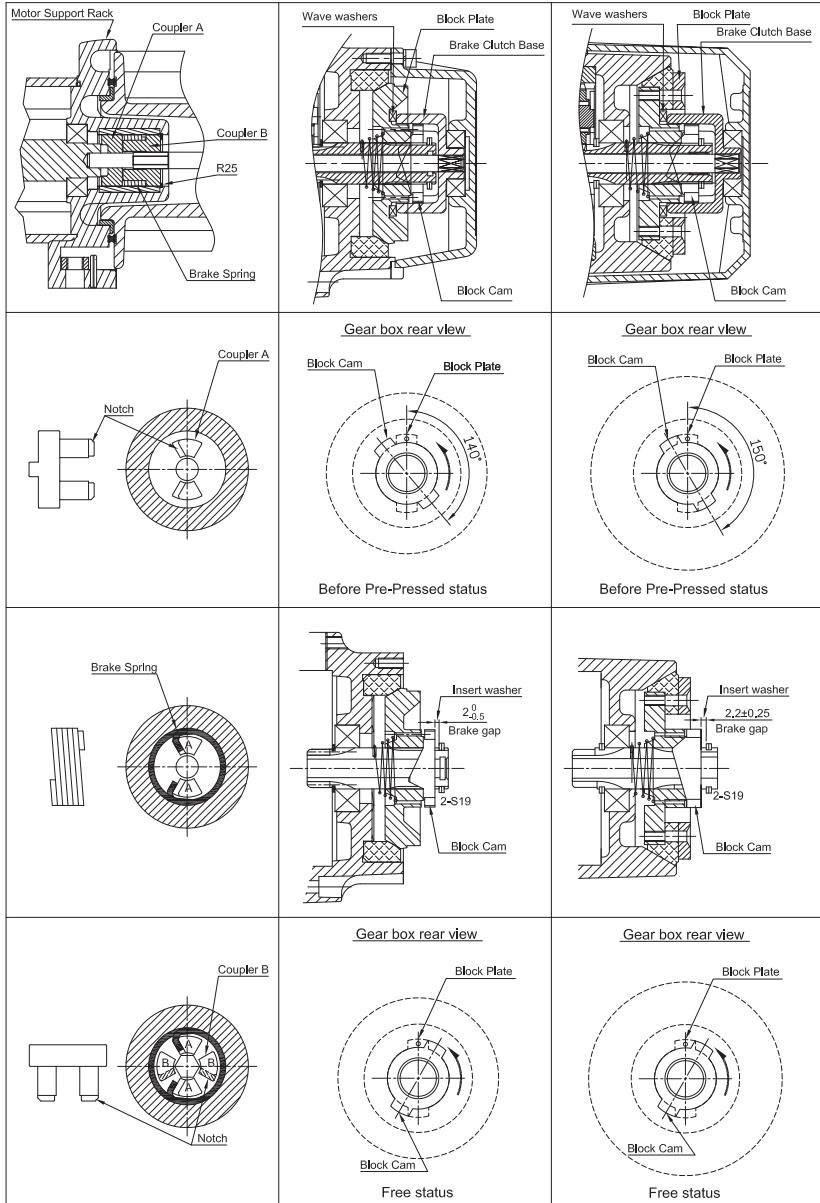

► Maintenance Schedule

1. Ensure that a responsible person carries out all inspections as per schedule.
2. Inspections are divided into Daily, Monthly and Quarterly.
3. Always keep the hoist and accessories free of dirt, oil, grease, water and other substances.

Classification of check			Item	Checking method	Checking reference	
Daily	Periodical					
	Monthly	Quarterly				
<input type="radio"/>			Installation	Mounting bolts & alignment	Bolt tension & wear	Existence of abnormalities
<input type="radio"/>			Remote control / contactor	Working	Manual	Reasonable actuation
		<input type="radio"/>		Wearing in contact points	Visual	Free of wear or damage
	<input type="radio"/>		Wire rope	Broken strands	Visual, measuring	Less than 10%
	<input type="radio"/>			Decrease in rope diameter	Visual, measuring	7% of nominal diameter max
	<input type="radio"/>			Deforming or corrosion	Visual	Existence of abnormalities
	<input type="radio"/>			Fastening condition of end	Visual	Existence of abnormalities
	<input type="radio"/>		Wirings	Fastening condition of terminals	Visual	Free of corrosion and tightening terminals
		<input type="radio"/>	Motor	Staining, damage	Visual evidence of wear	Existence of abnormalities
		<input type="radio"/>	Brake	Wearing of lining	Visual evidence of wear	Free of wear or damage
<input type="radio"/>				Performance	Visual	Reasonable actuation
		<input type="radio"/>	Gear train	Damage, wearing	Damage, wearing	Free of wear or damage
		<input type="radio"/>	Housing	Tie bar	Visual	Mounting surface is flat to within ± 0.5 mm
		<input type="radio"/>		Support racks	Visual	Free of bent or crack

VII. Trouble Shooting

When the hoist fails to operate after several attempts, or if there is any fault while

Symptom	Possible Cause	Remedy
Hoist will not operate	Cut circuit	Check battery lead
	Weak battery	Recharge or replace battery (at least 650CCA)
	Damaged circuit breaker	Replace circuit breaker
	Bad connection of wirings	Reconnect tightly
	Damaged contactor	Replace contactor
	Cut circuit on switch	Replace switch
	Damaged motor or worn carbon brush	Replace motor or carbon brush
Motor runs in one direction	Dropt or lost motor wiring	Tighten wirings
	Broken wiring or bad connection	Reconnect or replace wiring
	Damaged or stuck contactor	Replace contactor
	Switch inoperative	Replace switch
Hoist won't lift rated load	Dropt or lost wiring	Replace wiring and tighten, wirings
	Considerable voltage drop exceeds by 10% of the rated voltage of 12V DC or 24V DC.	Correct leads size Replace battery as bad condition Clean and tighten the wirings
No brake	Damaged brake cam and disc	Replace brake cam and disc
	Damaged gear box	Replace gear box
	Dropt snatch ring	Replace snatch ring
	Oil leakage at brake	Clean oil leakage
	Damaged or inoperative spiral spring	Replace and position spiral spring
Brake distance is too long	Damaged or stuck solenoid	Replace solenoid
	Worn or damaged brake	Replace or adjust brake
	Oil leakage at brake	Clean oil leakage
Damaged gear train	Damaged or stuck solenoid	Replace solenoid
	Hit by certain exterior force	Replace the damaged components
	Damaged gear train	Replace the damaged components
Motor runs extremely hot	Over load operation	Replace a new hoist
	Long period of operation	Allow to cool
	Damaged motor	Replace or repair motor
Hoist vibrates badly or is noisy	Damaged or inoperative brake	Replace or repair brake
	Damaged brake	Replace or repair brake
	Mounting surface is not flat	Make sure mounting surface is flat
	Tie bar is bent	Replace tie bar
	Crack on the motor and gearbox support racks	Replace racks

COMEUP

COMEUP INDUSTRIES INC.

No.139, Jieyukeng Rd., Ruifang Dist., New Taipei City 22453, Taiwan

TEL:+886-2-24971788 FAX:+886-2-24971699

Email: info@comeup.com.tw

<http://www.comeupwinch.com>

882480 Ver:03

Specifications subject to change without notice