

COMEUP

COMPACT WINCH

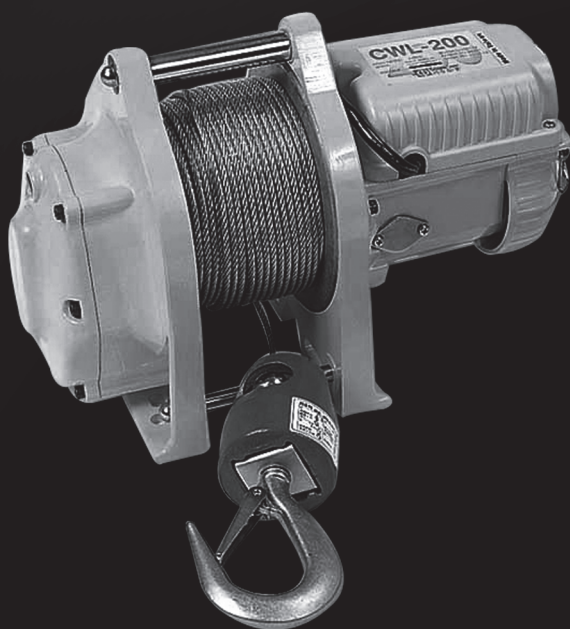

INSTRUCTION MANUAL



Limited One (1) Year Warranty Statement

Comeup Industries Inc. (**COMEUP**) warrants to the original purchaser that the mechanical components and electrical components of the **COMEUP** Compact Winch will be free of defects in material and workmanship for one (1) year. All **COMEUP** mounting kits and other accessories carry one (1) year limited warranty against defects in material workmanship.

This Warranty applies only to the original purchaser of the winch. To obtain any warranty service, the Purchaser under this Limited Warranty is requested to report **COMEUP** or his authorized distributors of any claims. The Purchaser must provide a copy of the proof of purchase bearing the winch serial number, date of purchase, owners name email, or Tel & Fax, address and registration number. Any product **COMEUP** determines to be defective will be repaired or replaced at **COMEUP** sole discretion without charge to Buyer upon Buyer's compliance with these procedures. Seller or its Authorized Distributors may make reasonable charges for parts and labour for repairs not covered by this Limited Warranty.

COMEUP takes the responsibility for all parts and components to be free from defects in materials and workmanship, but the following are hereby excluded and disclaimed:

- (1). All warranties of wire rope assemblies after initial use.
- (2). All warranties of fitness for a particular purpose.
- (3). All warranties of the product's finish
- (4). All warranties of merchantability

The Limited Warranty does not cover any failure that results from improper installation, operation or the Purchaser's modification in design. **COMEUP** reserves the right to change Product design without notice. In situations in which **COMEUP** has changed a product design, **COMEUP** shall have no obligation to upgrade or otherwise modify previously manufactured products.

Thank you for purchasing a **COMEUP** Winch. This manual covers operation and maintenance of the winch. All information in this publication is based on the latest production information available at the time of printing.

General Safety Precautions

The winch has been designed to give safe and dependable service if operated according to the instructions. Please read and understand this manual before installation and operation of the winch.

Follow these general safety precautions:

- Confirm that the winch complies with the using conditions.
- Keep the winch secure strongly and the rope is not wound to be deviated to the drum.
- Don't use unsuitable pulleys or accessories concerned.
- Don't use unsuitable rope in construction, strength or having any defects.
- Pay attention to the grounding, it provides a path of least resistance for electric current to reduce the risk of shock.
- Check the winch for smooth operation without load before loading operation.
- Make sure the wire rope to be wound evenly in the first layer on the drum, rewind it if a mixed windings in existence.
- If a wire rope is found an uneven winding or accumulated at one side of the drum, align it adequately.





WARNING

1. The winch is not to be used to lift, support or otherwise transport personnel.
2. A minimum of five (5) wraps of rope around the drum is necessary to support the load rated.
3. The owner and/or the operator shall have an understanding of these operating instructions and the warning before operating the electrical winch. Failure to follow these warnings may result in loss of load, damage to the winch, property damage, personal, or fatal injury.
4. The owner shall retain this manual for further reference to important warnings, installation, operating and maintenance instructions.

I. Installation Precaution

► General Safety Precaution

 DANGER	
	The following environmental conditions may result in the possible causes of hoist trouble.

- Low temperature below -10°C ,high temperature above 40°C or humidity above 90% conditions

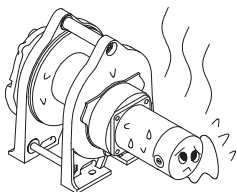

※Cause malfunction of spare parts

- In an organic chemistry or explosive powder conditions

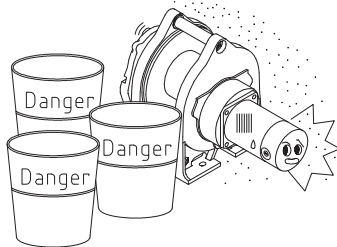

※Cause explosion

- In heavy acid or salty conditions
- In rain or snow conditions

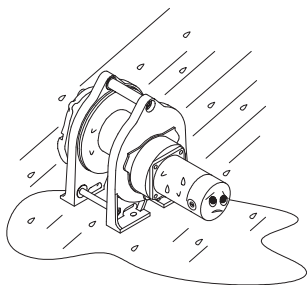

※Cause malfunction of spare parts
※Cause rust or short circuit

- In a heavy general powder conditions

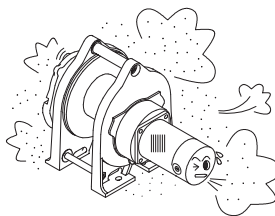

※Cause malfunction of performances

II. Handing Precautions

- * To prevent the risk of electric shock, the power plug must be plugged into a matching outlet and grounded in good condition.
- * Never try to lift a load higher than the rated cap.
- * Never hitch a ride on the hook, sling or load being moving.
- * Winches are not to be used for lifting or lowering people.
- * Don't work, walk or stand under an operating winch.
- * Always remain in control. Never neglect the winch while actually lifting a load.
- * While working, never stand under a lifting load or within the conveying area.
- * Always look up when working around winch, there is potential danger overhead.
- * Never gravitate a load free.
- * Be sure to lift a load vertically. Slack may allow wires to be caught in the drum.
- * A minimum of five (5) wraps of rope around the drum is necessary to support the load rated.
- * Prior to starting of use, carry out the daily checking without fail, and after confirming the safety of function.
- * If having a counter rotation incurred, make sure to correct its rotation direction.
- * Prior to lift. Make sure to have a precise performance of brake. If any malfunction of brake happened, stop the operation immediately.
- * When load suspended in air, it will not allow to be welding.
- * Wire rope with one or more of the following defects shall be removed or replaced immediately.
 - 1) kink,
 - 2) distortion,
 - 3) corrosion.
 - 4) showing sings of excessive wear or of having broken wires not less than 10 pcs.
- * Stop the operation if there is any queer noise or vibration in the gear box to be happened.
- * Do not connect the wire rope with the grounding of welding machine.
- * While welding, do not have any contact with the welding objects because of having spark.
- * Do not pull the switch.
- * Never plugging (instant reverse-wind) or inching.
- * Do not over continuous ratings.
- * In order to prevent the layer down due to over loosening of rope irregular winding, etc., operate according to the suitable operating method.
- * Use a winch by fixing so securely that the rope around the drum is uneven.
- * Be sure to fix a rope in the center of swivel hook.
- * Be sure to stop operation immediately when the wire rope becomes fully slackened.
- * Avoid catching the hook or lifting a load on a fixed obstruction.
- * Always leave the pendant switch positioned immediately after use.
- * Make sure that the load being lifting is well balanced and secured before starting.
- * Avoid water splashes on the pendant switch.
- * Never wrap the load with the wire rope.

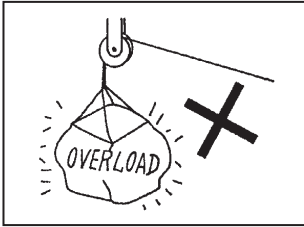

- It is forbidden to lift loads above the rated capacity of the winch

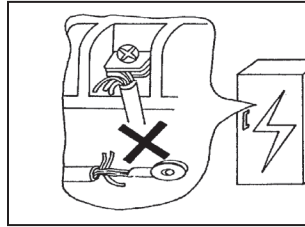

- Do not connect the power lead on the main power source directly and fasten them

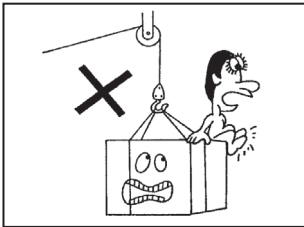

- Ban on transporting persons

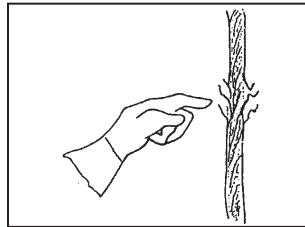

- Don't ignore fault accessories

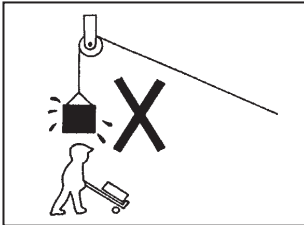

- Don't stand under winching operation



- Don't operate winch in rain.

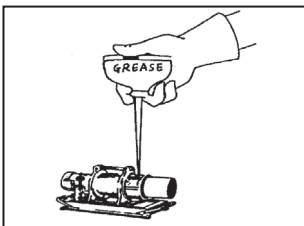

- Do perform maintenance on schedule

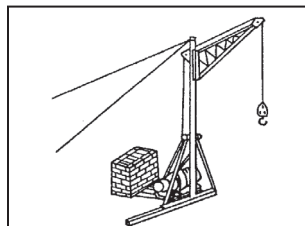

- Do anchor crane with ballasted container and wire rope

III. Winching Principles

► Percentage Duty Cycle

 <b style="font-size: 1.2em; margin-left: 10px;">WARNING
<div style="display: flex; align-items: center;"> <div style="border: 1px solid black; border-radius: 50%; width: 20px; height: 20px; margin-right: 10px; display: flex; align-items: center; justify-content: center;"> ⊘ </div> <div> <p>Never hoist over the rated percentage duty cycle.</p> </div> </div>

The life of the winch is depending on the conditions of the load and working frequency. In the long time operation, make sure to use the machine within its continuous ratings. Continuous ratings means the percentage duty cycle (%ED) is subject to the rated voltage, rated frequency and a 63% of rated load.

$$\text{Percentage duty cycle (\%ED)} = \frac{T_b}{T_b + T_s} \times 100 (\%)$$

T_b : total sum of overall loadings operating hours.

T_s : total sum of stopping hours.

$T_b + T_s =$ approximately 1 to 10 minutes.

For this reason, all compact winches are rated at a 25% percentage duty cycle (%ED).

► Load Rated

Load and speed vary according to how much wire rope is on the drum. The first layer of rope on the drum delivers the slowest speed and the maximum load. A full drum delivers the maximum speed and the minimum load. For this reason, all compact winches are rated at their top layer of wire rope on the drum.

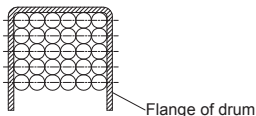

► Calculating Head Loads

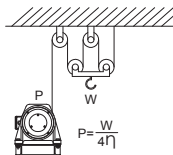
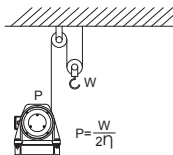
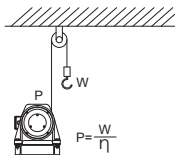

- P: Rope tension
- η : Sheave efficient
- θ : Angle
- W: Load
- μ : Friction factor

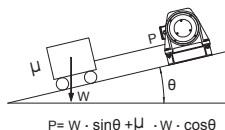
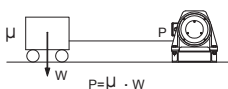

Use a tackle block for double fall operation to increase the rated load by approximately 85% but its speed will be deducted by half accordingly.

► Calculating Fleet Angle

- The winch should be mounted as close to centre and as perpendicular as possible to the direction of the line pull. This will keep the wire rope fleet angle centre on the drum as small as possible.
- If the proper fleet angle is not maintained, the wire rope could wind onto one side of the drum.

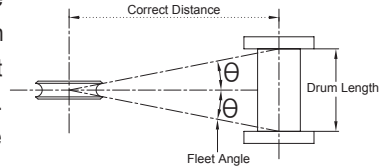

Experience has shown that the best wire rope service is obtained if the maximum fleet angle is not more than 1.5° for smooth drum.

For example, the correct distance varies according to drum length.

Model	CWL-80	CWL-200	CWL-301	CWL-200L	CWL-301L
Drum Length	46 mm	97 mm		147 mm	
Correct Distance	87.4 cm at least	1.84 m at least		2.79 m at least	

► D/d Ratio

It means ratio of pitch circle diameter of drum to the rope diameter.

In principle, a 12:1 D/d ratio is suggested for most pulling application and a 15:1 D/d ratio for lifting and lowering applications. For example, a CWL-200 comes with a 95 mm dia. drum and a 5 mm x 46 m wire rope, therefore its D/d ratio is calculated as follow.

$$D/d \text{ ratio} = (95 + 5 \text{ mm}) / 5 \text{ mm} = 20 \text{ times}$$

► Rope Safety Factor

The working coefficient of the wire rope shall be determined from the ratio of the minimum breaking force of the rope and the maximum possible lifting capacity.

In principle, a 3.5 times of rope safety factor is suitable for most pulling applications and a 5 times for lifting and lowering applications. For example, a CWL-200 comes with a 5 mm x 46 m wire rope with 1,270 kg minimum breaking force, therefore its rope safety factor is calculated as follow.

$$\text{Rope safety factor} = 1,270 \text{ kg} / 200 \text{ kg} = 6.35 \text{ times}$$

IV. Compliance with EU Directives

► Electric Winches shall comply with the following regulations

1. European Standards of EN 14492-1 for Power Driven Winches came to effect from 29th December 2009
2. European Machinery Directive 2006/42/EC.
3. European Directive on Electromagnetic Compatibility (EMC) 2004/108/EC
4. European Low Voltage Directive (LVD) 2006/95/EC

► Extracts from the Directives

1. EN 14492-1 Section 5.15.6 Wire Rope
Wire rope minimum break to be twice winch rating
2. EN 14492-1 Section 5.7.2 Rope Drum
Rope drum mean diameter to be 10 times the diameter of the wire rope and the flanged drum end plates shall protrude beyond the rope wound on the drum at the top layer by at least 1.5 x the nominal rope diameter.
3. EN 14492-1 Section 5.7.6 Rope Fastening onto the rope drum
Rope attachment to withstand 2.5 times the winch rating
Rope must have at least two wraps winding before fixing point
4. EN 14492-1 Section 5.15.5 Brake
Winch to hold full rated load
5. EN 14492-1 Section 5.15.2 Rated Capacity Limiters
Winch for lifting and lowering purpose with a rated capacity of 1,000 kg or more shall be fitted with a rated capacity limiter to prevent overloading of the winch

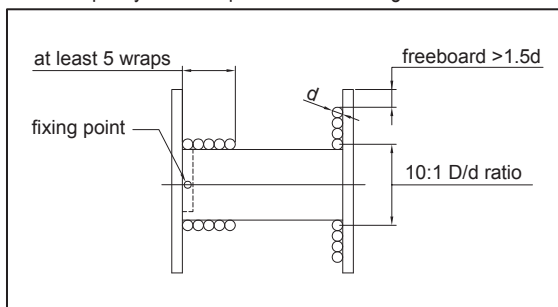

► To comply with EN 14492-1, the following optional accessories must be fitted to all winches

- Low voltage control
- Remote control w/ an emergency stop button
- Rope drum cover
- Up and down limits protection devices

When using and installing a winch, the owner or end user shall ensure that all legal requirements are completely complied with.

V. Working Method

► Power Core Insertion

Insert the power plug into the power receptacle of the winch, and tighten it by turning the locking ring, clockwise. Be sure to lock the cord by a hook. Do not allow the cord to be caught by wire rope and drum.

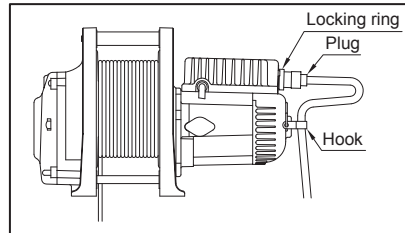

► Cords Sections

The length for power lead or switch cords are subject to the distance of 20 meter, for any other cases, the cords should use a bigger section by 3.5 mm^2 or a magnetic control box should be suggested to prevent a considerable voltage drop to be happened.

Winch model	Lifting capacity	Power Lead	Switch Cord
CWL-80	80 kg	$1.5 \text{ mm}^2 \times 3\text{C} \times 3 \text{ m}$	$1.25 \text{ mm}^2 \times 6\text{C} \times 3 \text{ m}$
CWL-200/200L	200 kg	$1.5 \text{ mm}^2 \times 3\text{C} \times 3 \text{ m}$	$1.25 \text{ mm}^2 \times 6\text{C} \times 10 \text{ m}$
CWL-301/301L	300 kg	$3.5 \text{ mm}^2 \times 3\text{C} \times 0.6 \text{ m}$	$2.0 \text{ mm}^2 \times 6\text{C} \times 10 \text{ m}$

► Grounding

To prevent the risk of electric shock, the power plug must be plugged into a matching outlet and grounded in good condition.

► Up and Down Switching

To lift a load, press \uparrow button and drum will rotate as shown below operation.

To lower a load, press \downarrow button and drum will rotate as shown below.

To stop winching, release \uparrow or \downarrow button.

To have an emergency stop function, press the emergency stop button (option). Rotate the button clockwise for returning.

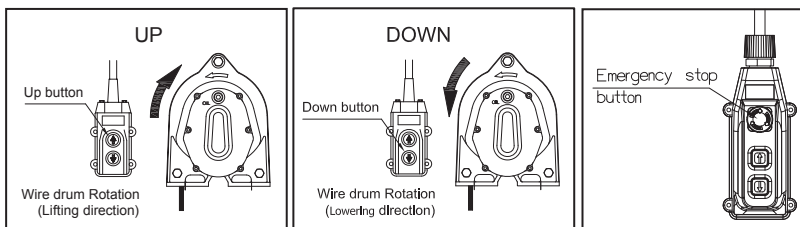



Winch Model	Pendant Switch, Standard	Pendant Switch w/an emergency stop, Option
CWL-80	CPB-413, 16A 2a1b	PB-316A, 16A 2a1b
CWL-200/200L	CPB-313, 16A 2a1b	PB-417, 2a1b + Emergency Stop 1a1b
CWL-301/301L	CPB-313, 16A 2a1b	PB-417, 2a1b + Emergency Stop 1a1b

► Wire Rope Replacement

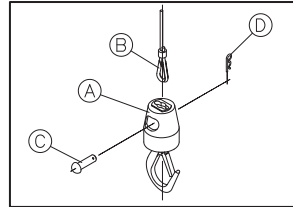
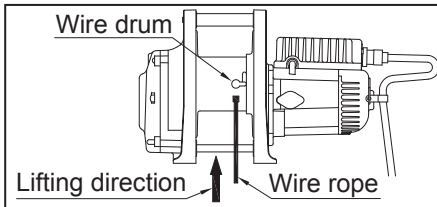
- Insert the wire rope into the hole of drum and fix it with a P. T. screw, then press the ↑ button of switch for rotate the drum in the lifting direction.
- Wind the wire rope accurately around the drum, and an irregular winding will cause the load to be swing, thus damaging the wire and reducing the life of winch.
- When replacing, according to the following procedures.
 - * Pull out an R-dowel "D" from the round head pin "C".
 - * Pull out a round head pin "Cc from hook body "A".
 - * Put a wire rope "B" into the hole of hook body "A", and insert a round head pin "C" through wire rope and fixture hole of hook body "A".
 - * Insert an R-dowel "D" into the hole of round head pin "C".



► Carbon Brush Replacement

 WARNING	
	Clean the accumulated powder of carbon brush periodically to ascertain the insulation resistance up to 1MΩ.

- It is essential to check the carbon brush periodically. If its length is left less than 7.5 mm resulting from wear, it is absolute necessary to replace carbon brush immediately.
- While replacing, smoothly insert carbon brush into carbon holder in the first place, then put brush cap into the hole.
- Before tightening the carbon brush holder, make sure to position O-ring.
- A set of carbon brush consists 2 piece of carbon brush. Ascertain to replace 2 pieces of carbon brush on opposite sides of winch body at the

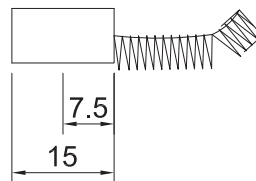
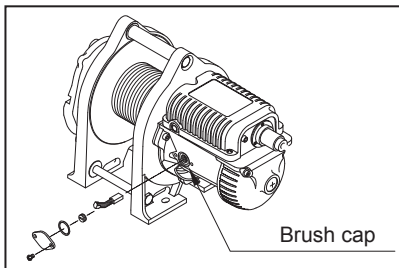

► Braking

- Braking device is composed of a mechanic brake and an electronic generated brake. The brake distance from the time of braking until stopping completely should be within 1.5% of rope length to the wound in during 1 minute.
- Owing to the rope speed on no load is 1.5 – 1.8 times faster than that on rated load, the brake distance on no load will be longer, but still within 1.5% of rope length.
- It is highly recommended that any adjustments are carried out by a qualified technician at an authorized service centre.
- Brake adjustment procedures
 - Step1. Remove retaining ring and spring pin
 - Step2. Tighten 1st gear/2nd shaft for CWL-80 or 3rd gear /4th shaft for CWL-200/200L/301/301L counter-clockwise until holding to the ratchet
 - Step3. Find the closed pole between spring pins and fit plate (one between four selections), then put the fix plate onto the square hole of 3rd or 4th shaft.
 - Step4. Insert spring pins and lock retaining ring.

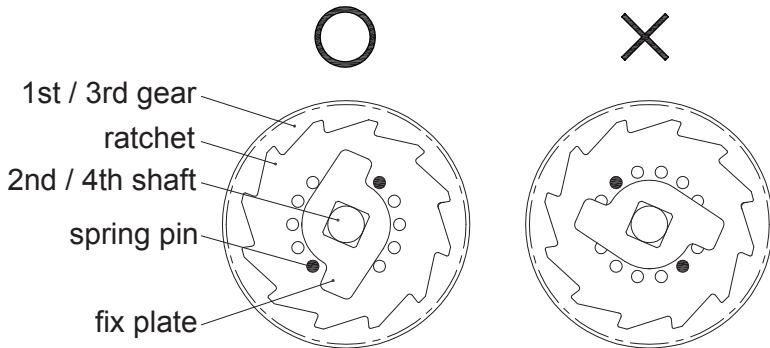

► Oil Replacement

Gear lubrication is an important component in insuring the long life of your winch. Winch are pre-lubricated at the factory and do not require initial lubrication. Re-lubrication interval depends upon service, 250 working hours of a year, or after repair or disassembly. Consult your local lubricant distributor on the selection that best fits your climate and application.

Gear Oil	Quantity					Intervals
	CWL-80	CWL-200	CWL-200L	CWL-301	CWL-301L	
Castrol Alpha series SP-460	100 cc	300 cc	300 cc	300 cc	300 cc	1 Year or 250 Working hours
Shell Omala 460						
BP Energol GR-XP 460						
Mobil XMP 460						
Esso Spartan EP460						

VI. Cart Puller Capacity

► Choose the Right Winch

In most pulling applications you are dealing with a rolling load rather than pulling a dead weight. Resistance to rolling is mostly influenced by the load, rolling resistance, track gradient, track curvature, track conditions etc.

- **Load:** Calculate the total weight of the loaded cart to be moved simultaneously.
- **Rolling resistance:** Resistance to rolling is influenced by the wheel journals, type of lubrication used and the ambient temperature.
- **Track gradient:** For each one percent gradient, a rise of one meter for every 100 meter of track, the running line pull must be increased by 10 kg per ton.
- **Track curvature:** To overcome the effects of wheels binding against rails on curved sections of track, running line pull must be increased. For each degree of curvature, the running line pull must be increased by 1kg per ton.
- **Track conditions:** The condition of substandard track can vary considerably.

► Application Condition Example

- 1). Pulling of a rolling cart in and out of an oven using a single wire rope
- 2). 5 ton total load being moved included weight of cart
- 3). Steel cart wheels with precision wheel bearing
- 4). New track, 5° curvature and 2% gradient

► Pulling Capacity Required

	5 ton.....	Total weight being moved
x	(10 kg+20 kg+5 kg) 10kg.....	Pull required per ton being moved
	175 kg	20kg.....
		For each one percent gradient, the running line pull must be increased by 10 kg/ton
		5kg.....
		For each one degree of curvature, the running line pull must be increased by 1 kg/ton
x	1.2	20%.....
	210 kg	contingency for unpredictable track or cart conditions
	Minimum calculated cart puller capacity

► Horizontal Load Reversing

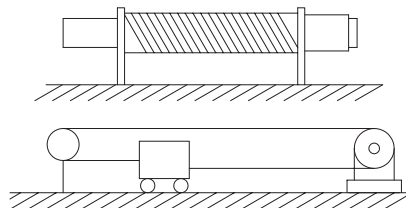

The horizontal load reversing allows 2 pieces of wire rope to be spooled onto the first layer of grooved drum. As one rope winds onto the drum and the other rope winds off an equal amount. It is important to know how each of the wire rope will be coming off of the drum, that allows the correct grooving to be provided.

VII. Wiring Diagram

► CWL-80 Winch

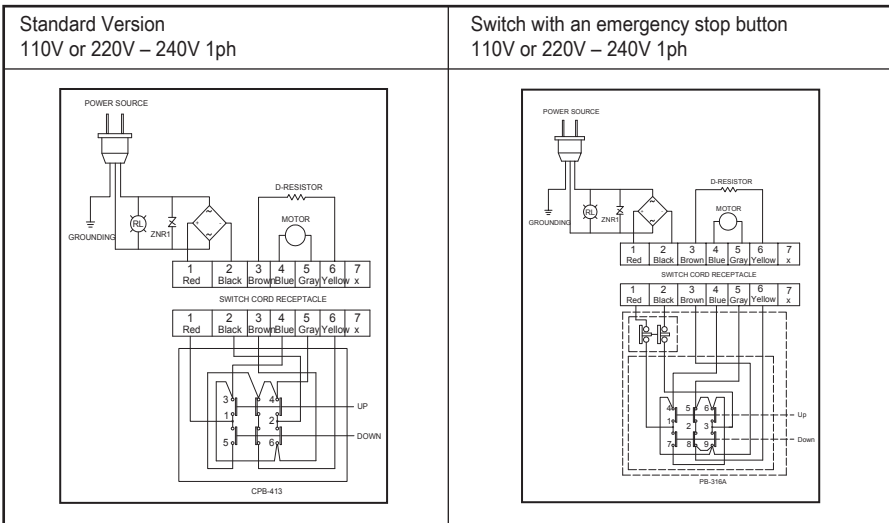

► CWL-200/301/200L/301L Winches

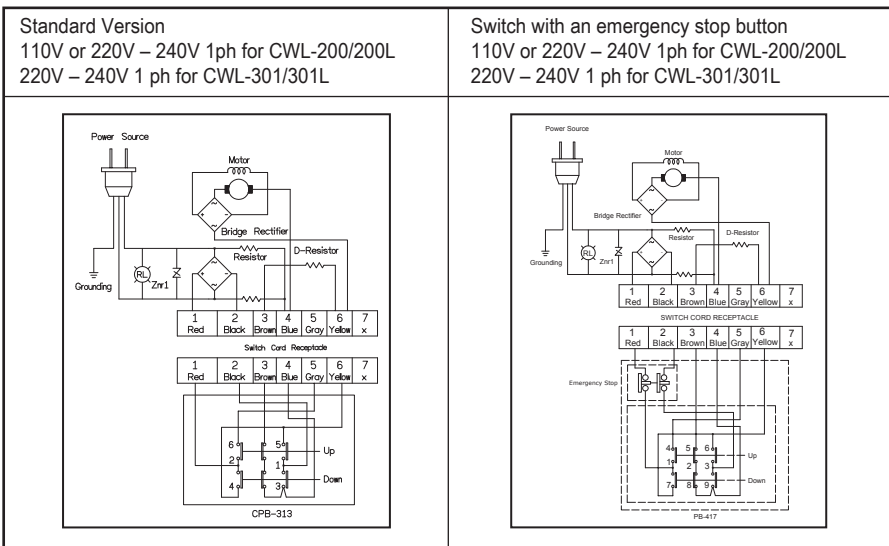

VIII. Checking and Trouble Shooting

► Checking Reference

- Remark : 1. The specified person performs the checking of winch.
 2. Divide the checking into daily checking and periodic checking.
 3. The checking items and checking method in daily and periodic checking shall be carried out and different according to the using frequency.

Checking items			Checking Methods	Classification of Checks			
				Daily	periodical		
					3 Months/ 20 Hours	1 year	3 Years or 250 Hours
1	Brake	Performance Wearing of lining, and pressed plate Brake or escaping of spring	Visual Decomposition check Decomposition check	▲			▲ ▲
2	Carbon brush	Wearing	Decomposition check		▲		
3	Motor	Condition of insulation Staining , damage Carbon powder accumulation	Measuring,1MΩmin Visual Decomposition check	▲	▲		▲
4	Remote control	Working Outer damage of switch cords Attaching condition of earth line Condition of insulation	Manual Visual Visual Measuring,1MΩmin	▲ ▲ ▲	▲		
5	Safety device	Over-prevention function Reverse winding prevention function Distortion of over winding lever Wrong rotary direction-winding	Visual Visual Visual Visual	▲ ▲ ▲ ▲			
6	Wire rope	Kink phenomena Broken wires Decreasing of diameter more than 10% Deforming or corrosion	Visual Visual Visual Visual	▲ ▲ ▲ ▲			
7	Weight hook and hanger	Distortion Damage Loosening	Visual Visual Visual	▲ ▲ ▲			
8	Drum	Rupture of flange Wearing	Visual Visual	▲	▲ ▲		
9	Gear trains	Damage , warning Condition of oil feeding Lubrication for couplings	Visual Measuring Measuring	▲			▲ ▲
10	Fastenings	Loosening	Manual	▲	▲	▲	
11	Marking	Label and the like	Manual	▲			

► Trouble Shootings

Checking the winch for smooth operation by pressing ↑ or ↓ button of pendant switch.

When winch fails to start after several attempts, or if any defective operation to be happened, check followings.

Symptom	Possible cause	Remedy
No reaction or open circuit	Open circuit on power lead or switch cord	Check power lead or switch cord
	Burnt rectifier at power source side	Replace rectifier and pay attention to its poles
	Burnt motor	Replace motor
	Burnt or communicated motor resulting from over load.	Replace motor
	Improper installation or wearing of carbon brush	Check or replace carbon brush
	Escape or open circuit of carbon brush lead	Check or replace carbon brush lead
Can lift, but fail to lower	Burnt diode	Replace diode and pay attention to its poles
	Burnt rectifier at motor side	Replace rectifier and pay attention to its poles
	Malfunction of the Down contact of the pendant switch	Replace pendant switch
Can lower, but fail to lift	Loose adjustable nut	Adjust
	Burnt diode	Replace diode and pay attention to its poles
	Burnt rectifier at motor side	Replace rectifier and pay attention to its poles
	Malfunction of the Up contact of the pendant switch	Replace pendant switch
Short circuit	Melted B contact of pendant switch	Replace pendant switch
	Burnt diode	Replace diode and pay attention to its poles
	Short circuit on rectifier at motor side	Replace rectifier and pay attention to its poles
	Burnt D type resistor	Replace resistor
	Having too much carbon powder on carbon brush holder	Disassembly the winch and clean carbon powder
	Burnt motor	Replace motor
Fail to lift the load rated	Damaged circuit board resulting from the winding-in of rope	Replace circuit board
	Overload	Reduce load
	Short circuit on the commutator of the armature core or burnt parts of armature coils.	Replace commutator of the armature core
	Burnt parts of armature winding.	Replace armature winding
	Incorrect carbon brush specification or too short	Replace carbon brush
Fail to hold the load after stopping	Burnt, deformation of carbon brush holder	Replace carbon brush holder
	The gap of ratchet brake is too large	Adjust the ratchet brake
	Malfunction of pressed spring of ratchet brake	Replace pressed spring
	The oil is too dirty or includes contamination	Replace oil
Brake distance is too long at no load	Having too much oil in gear box	Reduce the quantity of oil
	Malfunction of D type resistor	Check or replace D type resistor
Having smell or smoke	Malfunction of pressed spring of ratchet brake	Replace pressed spring
	Burnt D type resistor	Replace D type resistor
	Malfunction of B contact of the pendant switch	Replace pendant switch
Too noise whiling lifting	The noise result from the click between ratchet stopper and wheel	It is normal

COMEUP

COMEUP INDUSTRIES INC.

No.139, Jieyukeng Rd., Ruifang Dist., New Taipei City 22453, Taiwan

TEL:+886-2-24971788 FAX:+886-2-24971699

Email: info@comeup.com.tw

<http://www.comeupwinch.com>

PN 881412 Ver:03

Specifications subject to change without notice