

COMEUP WINCH

HYDRAULIC
HOIST



INSTRUCTION MANUAL



Limited One (1) Year Warranty

WARRANTY

Comeup Industries Inc. (COMEUP) warrants to the original purchaser that COMEUP Hydraulic Hoist will be free of defects in material and workmanship for a period of one (1) year from the original date of purchase. All COMEUP mounting kits and other accessories carry a one (1) year limited warranty against defects in material workmanship.

This warranty applies only to the original purchaser of the winch. To obtain any warranty service, the purchaser under this Limited Warranty is requested to advise COMEUP or its authorized distributors on any claim. The purchaser must provide a copy of the purchase receipt bearing the winch serial number, date of purchase, owners name, email or Tel & Fax, address and purchaser vehicle details. Any products that COMEUP determines to be accountable for defective will be repaired or replaced or refund at COMEUP sole discretion without charge to buyer upon buyer's compliance with these procedures. In the event of repair or replace, purchaser must send the defective winch or part, with freight prepaid, to COMEUP or its authorized distributor. And COMEUP will send the serviced product back to purchaser on COMEUP's cost. This warranty does not cover the removal or reinstallation of the winch.

COMEUP takes the responsibility for COMEUP winch parts and components to be free from defects in materials and workmanship, but the following portions are hereby excluded and disclaimed. COMEUP or its authorized distributors may make reasonable charges for parts and labour for repairs or resumption in the following portions not covered by this limited warranty.

- (1). All warranties of fitness for a particular purpose
- (2). All warranties of the product's finish
- (3). All warranties of merchantability

The limited warranty does not cover any failure that results from improper installation /operation,third party part substitution, purchaser's alteration or modification on COMEUP winch. This warranty is void when COMEUP serial number plate is removed or defaced.

COMEUP's liability to the purchaser under the winch purchases for any loss or damage howsoever and whatsoever arising shall not exceed the price of the initial winch purchase receipt. COMEUP shall not in any event be liable to the purchaser for any consequential and/or indirect loss or damage whether for loss or for profit or otherwise, costs, expenses or other claims for consequential compensation whatsoever and whether caused by negligence of COMEUP employees, distributors and their employees or otherwise. COMEUP reserves the right to change product design without notice. In situations in which COMEUP has changed a product design, COMEUP shall have no obligation to upgrade or otherwise modify previously manufactured products.

COMEUP WINCH

Hydraulic Hoist

Thank you for purchasing a **COMEUP** Hydraulic Hoist. This manual covers operations and maintenance of this Hydraulic Hoist. All information in this publication is based on the latest production information.

This Hydraulic hoist has been designed to give safe and dependence service if operated according to the instructions. Please read and understand this manual before installation and operation of this hoist. Careless winch operation might result in serious injury or property damage

Please comply with the following safety requirements

- Before operate the Hydraulic hoist, the users are required to clearly understand all the related legal regulations, and based on these regulations to install and operate the Hydraulic hoist.
- Make sure the operate circumstances are comply with the safety requirement to a Hydraulic hoist.
- Make sure that the hydraulic hoist has been installed firmly and steady in a proper location and space, also the wire rope could be properly winding in and out.
- Any accessories which are not complied with the regulations are recommended not to use. For examples, wire ropes and hooks.
- Please apply any materials or compositions of the wire ropes which are comply with the safety regulations. Do not use any wire ropes which are damaged, broken or not comply with the wire rope breaking load regulations.
- Before using the hydraulic hoist in regular lifting, run the hoist several times without loading, to make sure the hoist is well installed.
- Before operate the hoist, make sure every layers of the wire ropes is evenly winded on the drum, (especially the first layer). If the wire ropes are not properly winded on the drum or piled up in one side of the drum, please adjust the hoist into a horizontal condition and re-wire the wire ropes.



Warning

1. This Hydraulic hoist needed to be operated by professional and well trained personnel.
2. Do not use the hydraulic hoist for transport any personnel in any circumstance.
3. To ensure the hydraulic hoist can be operate in a safe way, minimum 5 wraps of rope left on the drum is a must.
4. The owner and/or the operator shall have an understanding of these operating instructions and the warning before operating the hoist. Failure to follow these warnings may result in serious property damaged or personnel injury.
5. The owner shall retain this manual for further reference to important warnings, installation, operating and maintenance instruction.
6. The wire ropes may be broken in any unaware situation. Hence, when operate the hydraulic hoist, it is necessary to keep away from the wire rope operation zone. Check the wire rope regularly or change the wire ropes if needed.
7. The loading performance for hydraulic hoist is rated by the top layer of the wire rope.

I. Installation and Operation

► General safety operation guidelines.

 Dangerous
● Below working circumstance may caused dangerous



- Extremely prohibited overload.

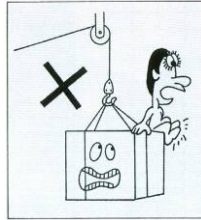

- Extremely prohibited transport for any personnel.

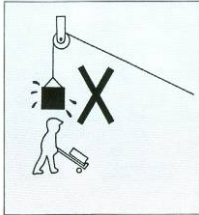

- Do not standing underneath the loading area.

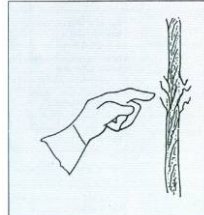

- Extremely prohibited to use any accessories which are not complied with the regulations. For example, wire ropes, hooks, switches and remote control etc...

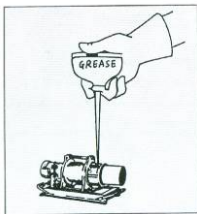

- Regularity maintenance the product.

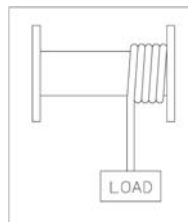

- A minimum of five wraps of rope around the drum is necessary to support the rated load.

II. Hydraulic system installation

(Powered by PTO / Power take off unit driven pump)

► APE series hydraulic hoist (STD)

V1 Lowering branch	V2 Hoisting branch	C3 Connection to brake
① Brake	② Hoist	③ Two-way counter balance valve
④ Control valve	⑤ Pressure relief valve	⑥ PTO electro control box
⑦ Hydraulic pump	⑧ Return filter	⑨ Suction filter
⑩ Oil tank		

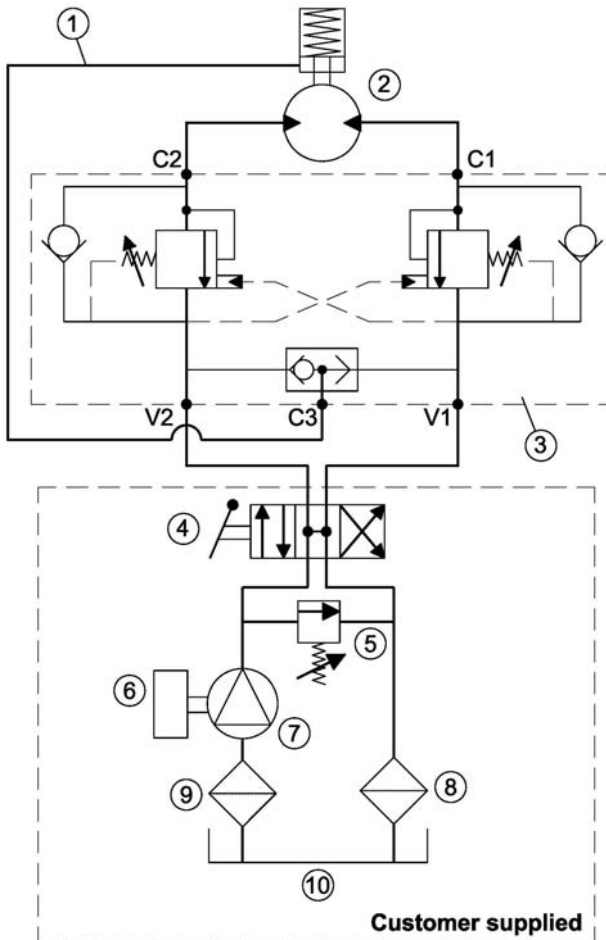

► APE series hydraulic hoist

V1 Lowering branch	V2 Hoisting branch	C3 Connection to brake
① Brake	② Hoist	③ Two-way counter balance valve
④ Control valve	⑤ Pressure relief valve	⑥ PTO electro control box
⑦ Hydraulic pump	⑧ Return filter	⑨ Suction filter
⑩ Oil tank	⑪ Solenoid valve	⑫ Upwards limit micro switch
⑬ Downwards limit micro switch		

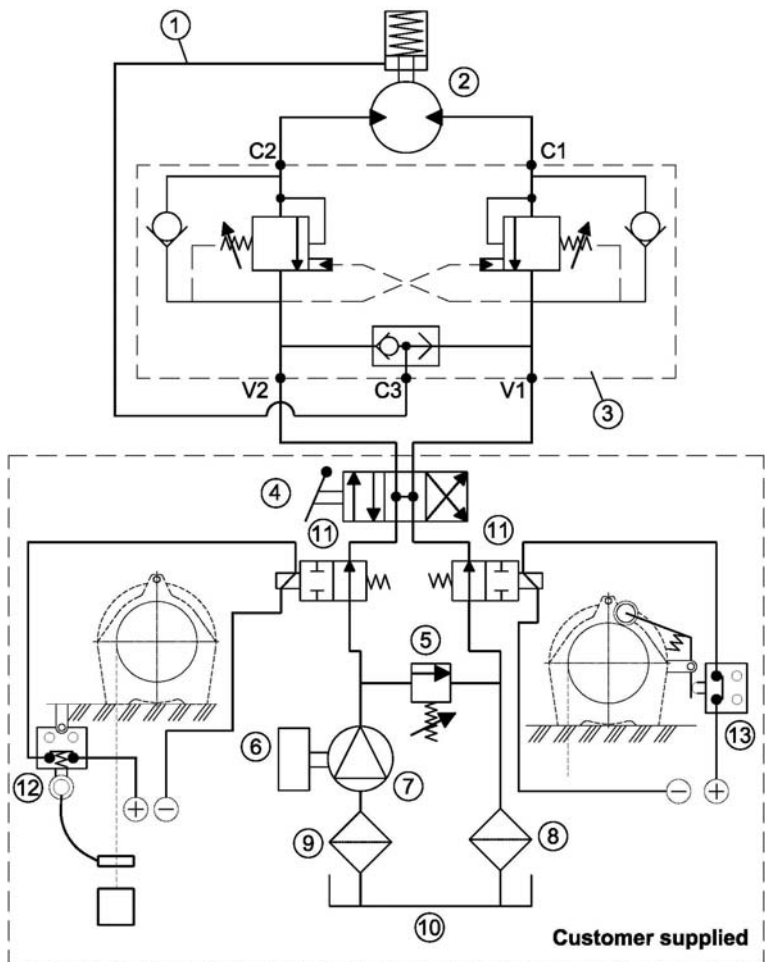

► **Hydraulic Fluid**

- The hydraulic fluid should be a high grade, petroleum based fluid, with rust, oxidation and wear resistance. Fluid cleanliness and operating viscosity are critical to winch reliability, efficiency and service life.

► **Hydraulic Pump**

- To maintain the maximum performance, the hydraulic pump must supply the maximum flow of hydraulic fluid at the hydraulic pressure stated in specification.
- With a max. oil supply mentioned on the instruction manual at top motor rpm and the pump must be capable of delivering the operation pressure mentioned on the instruction manual too.

► **Hydraulic Control Valve**

- The control valve must have a four-way spring return to neutral feature, which provides for open flow from the pressure ports of the winch to the reservoir in neutral position of the control (motor spool).

► **Hydraulic Pressure Relief**

- The hydraulic system requires a pressure relief set at the operating pressure.
- Failure to use the correct pressure and flow may result in damage to the winch, property or personal injury.

► **Hydraulic Reservoir**

- The hydraulic reservoir has sufficient capacity to provide good heat dissipation in order to prevent over-heating of the hydraulic fluid.
- Must be fitted with an oil filler device comprising strainer and filter and a dip stick. The capacity of the tank should be at least 60 liters.

► **Over-Center Valve / Counterbalance Valve**

- Give smoothly controlled winch out when under load and to provide full dynamic braking. It must be installed to hold full load.
- The Port A of over-center valve means the inlet port of oil from reservoir and the Port B meaning the return port of oil to reservoir.
- Over-center valve is a standard accessory for HV winch and counterbalance valve for Bison

► **Hydraulic Hoses**

- The following hydraulic hoses are recommended for maximum efficiency of the hydraulic winch. The bigger nominal bore hose, the better winch performance.
- All hose lengths are kept to a minimum because pressure and flow loss is increased as hose length increases.
- Pressure and return lines in excess of 3.5 meter (11.5") should be compensated with an increase in nominal bore size. Motor drain line pipe shall be rated at 1/4" BSP N.B.
Inlet line 1 1/4" – 1 1/2" nominal bore (N.B.) from reservoir to pump
Return line 1" (N.B.) from control to reservoir
Pressure hoses 1/2" (N.B.) from control valve to over-center valve

► Filter and Return filter

- Filter will filtration bigger impurities
- Return filter will filtration smaller impurities and insolubility dirt.

► Regulation for oil pressure with working pressure and rated pump flow

Model	APE-9	APE-12	APE-16	APE-19
Working pressure	140 bar	150 bar	205 bar	205 bar
	2,030 psi	2,176 psi	2,973 psi	2,973 psi
Max. Pump flow	35 l/min	40 l/min	45 l/min	60 l/min
	9.2 g/min	10.6 g/min	11.9 g/min	15.9 g/min
Min. Pump flow	15 l/min	20 l/min	15 l/min	20 l/min
	4.0 g/min	5.3 g/min	4.0 g/min	5.3 g/min
Fuel tank capacity	40 litre and above		60 litre and above	

III. Hoisting principles

► Percentage Duty Cycle

	WARNING
	Never hoist over the rated percentage duty cycle (30% ED)

The life of the hoist is depending on the conditions of the load and working frequency. In the long time operation, make sure to use the machine within its %ED ratings. Continuous ratings means the percentage duty cycle (%ED) is subject to the rated pressure, flow and a 63% of rated load

$$\text{Percentage duty cycle (\%ED)} = \frac{T_b}{T_b + T_s} \times 100 (\%)$$

T_b: total sum of overall loadings operating hours

T_s: total sum of stopping hours

T_b + T_s = approximately 1 to 10 minutes

The percentage duty cycle %ED of Hydraulic hoist is rated at their top layer of wire rope on the drum and rated at a 30% percentage duty cycle (%ED)

► Load Rated

Load and speed varies according to how much wire rope is on the drum. The first layer of rope on the drum delivers the slowest speed and the maximum load. The top layer of rope on the drum delivers the maximum speed and the minimum load. For this reason, all hoists are rated at their top layer capacities

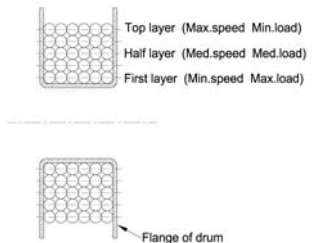

► Calculating Head Loads

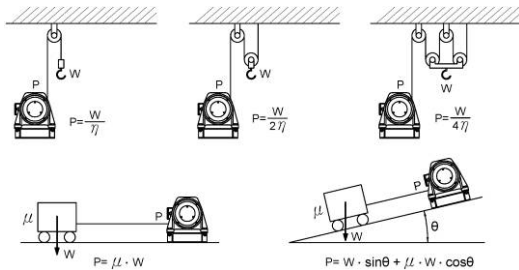

- P: Rope tension
- η: Sheave efficient
- θ: Angle
- W: Load
- μ: Friction factor

We assume that if we only use 1 tackle block for double lifting, due to $P=W/2\eta$, if the performance of tackle block does not calculate in, then the lifting weight can be doubled, but the speed and lifting length will decreased into half.

IV. Hydraulic hoist installation

► Calculating Fleet Angle

- The hoist should be mounted as close to centre and as perpendicular as possible to the direction of the line pull. This will keep the wire rope fleet angle centred on the drum as small as possible.
- If the proper fleet angle is not maintained, the wire rope could wind onto one side of the drum. This could cause failure of the hoist or wire rope, resulting in damage, injury or death.
- Experience has shown that the best wire rope service is obtained when the maximum fleet angle is not more than 1.5° for smooth drums.
- Therefore the correct distance between centre of drum and of should be derived as a fleet angle of 1.5° is the equivalents of approximately 19 cm of lead for each centimetre of overall drum length, but the biggest fleet angle cannot be over 2° to the drum.

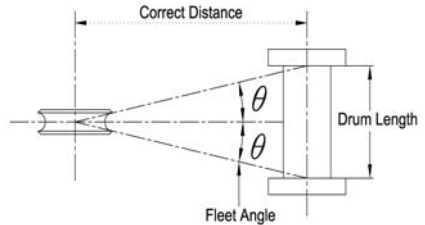

Model	APE-9	APE-12	APE-16	APE-19	APE-19 Long drum
Minimum distance between snatch block and Hoist	3.7m	3.7m	3.7m	3.7m	6.1m

- The drum for a Hydraulic Hoist, must be installed and maintain in a horizontal place, in order to both side of the hoist can be lubricated.

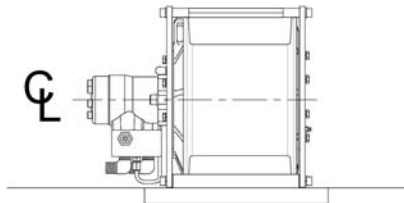

- The surface for install a Hydraulic hoist must be maintaining 0.5mm at least.

The surface for installing a hoist must be flat. In any of the area, the surface must be in flatness at most 0.5mm difference and also provide sufficient strength to support full loading without being bended or deformed.

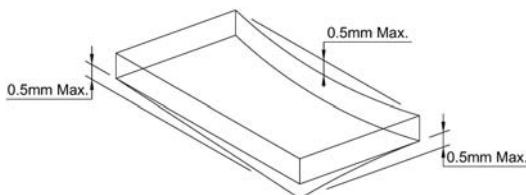

V. Hydraulic Hoist Operating

► Motor Rotation

L: Viewing from the backside of the motor, the oil enters from V2, and the drum rotates counter clockwise.

R: Viewing from the backside of the motor, the oil enters from V1, and the drum rotates clockwise.

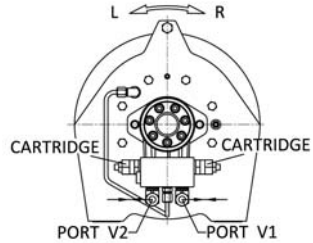

► Wire rope replacement

- 1). Remove M6X6L hexagon socket head screw.
- 2). Use a plastic hammer and flat head screw driver to knock out the old wire rope and fixed kit from the drum.
- 3). Take the wire rope fixed kit and old wire rope out.
- 4). Take the new wire rope go all the way through the side hole and wedge hole of the drum flange.
- 5). Fold the end side of wire rope into the wire rope fixed kit, (leave at least 5cm at the end of wire rope least 5cm). Use a plastic hammer and wire rope fixed kit to knock into the drum and wedge hole · tighten M6X6L hexagon socket head screw .

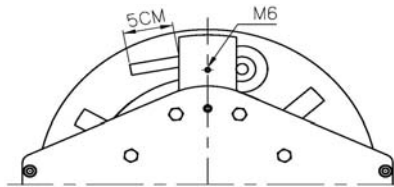
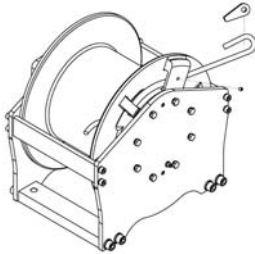

- 6). Wire rope must reserve at least 5 wraps on the drum and cannot be used, to ensure this hoist will be operating safely.
- 7). Please selects the wire rope with proper structure and materials which complies with related law or regulations.
- 8) Suggested wire rope capacity charts.

Model		APE-9	APE-12	APE-16	APE-19
Pulling	kg	900	1,200	1,600	1,900
	lb	1,984	2,645	3,527	4,190
Wire rope Diameter	EN	8mm	10mm	10mm	12mm
	ASME	5/16"	3/8"	3/8"	1/2"
Standard Drum	EN	68 m	55m	57 m	48 m
	ASME	223'	180'	187'	157'
Long Drum	EN	-	-	-	82 m
	ASME	-	-	-	269'
Wire rope grade		1,960 N/mm ² or EIPS			
Wire rope breaking load kN		44.7	69.8	69.8	100

*ASME is the wire rope regulation in ASME 30.7; EN is referring to the EU regulation of EN-14492

► Lubrication

- All the rotating parts have been lubricated while the hoist was assembled at the production line. In normal circumstances, Users will need to replenish lubricant from the replenish hole.

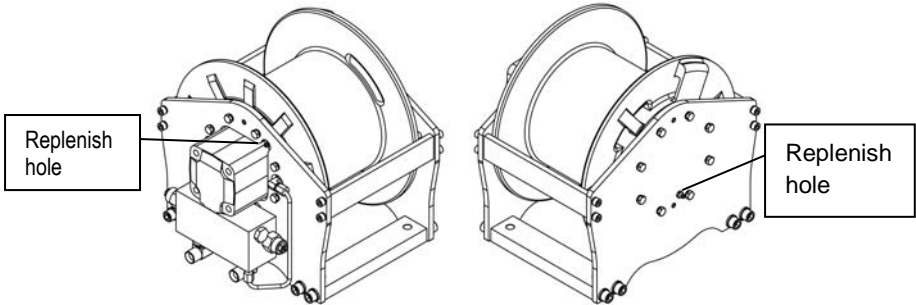

- When the gear box has been fixed or parts exchanged, please use the Castrol Alpha Spherol L-EP 2, Shell Alvania EP2, BP LS-EP2 or other same grade of lubricants (200cc) as supplement.

► Downwards limit micro switch adjustment

- Press the roller of the cable tensioner on the inner side of the drum.
- Press the lever on the limit micro switch, in order turn on the micro switch.
- Fastening the screw tightly, done.

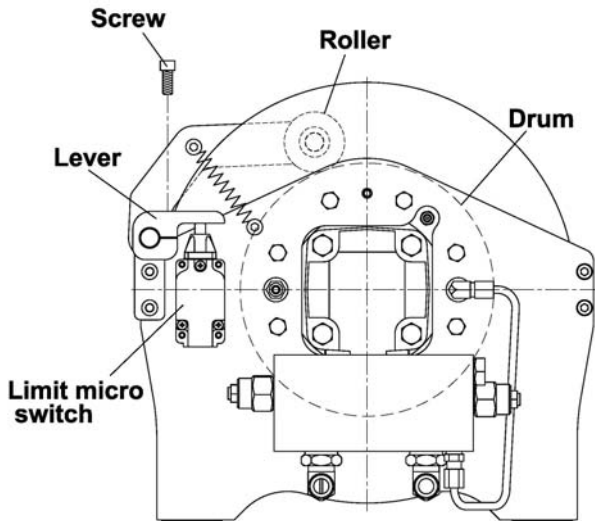

VI. Regular inspection

In most of the time, if the hydraulic hoist loses its function or performance, the main cause should always be the hydraulic system. Before dismantling or remove the hoist, check the entire hydraulic system to see if there is any problem? Operation pressure and oil flow must comply with the regulation of this manual.

► Inspection

- 1). The operator should take responsibility to check to hoist.
- 2). There are daily check and periodically check requirements for the winch.
- 3). Base on the check lists and checking methods, be sure to check the hoist daily and periodically,

Categories			Check lists	Methods	Importance	
Period	Daily	Monthly				Quarterly
	<input type="radio"/>		Installation	Tie bars	Tool	Tie bar loosen or not
	<input type="radio"/>		Wire rope	Damaged wire rope	Visual and measurement check	Less than 5%
	<input type="radio"/>			Diameter become smaller	Visual and measurement check	Less than 7%
	<input type="radio"/>			Tail fixed	Visual check	Not loosen
	<input type="radio"/>			Tie up, deformation or corrosion.	Visual check	No deformation and corrosion
	<input type="radio"/>			Hook	Abrasion or Damaged	Visual check
	<input type="radio"/>		Safety catch		Visual check	Normal function
	<input type="radio"/>		Drum	Flange deformation	Visual check	No deformation
	<input type="radio"/>			Diameter abrasion	Measurement	Less than 1 %
	<input type="radio"/>		Gearbox	Transmission	Visual and Listen	No noise or vibration
		<input type="radio"/>		Lubricants	Visual	Normal function
	<input type="radio"/>		Brake	Function	Visual	Normal function
		<input type="radio"/>		Abrasion	Measurement	No abrasion or damaged
	<input type="radio"/>		Marks	Tags or warning stickers	Visual	Not falling off

VII. Trouble shooting

If you have noticed that there are some problems or the hoist cannot be functioned normally, please check the hoist according to below check list. If the situation does not get better, please contact dealer for further after sales services.

Condition	Possible Clauses	Methods
The hoist cannot be loaded	Motor damaged	Dismantling motor, and then change or repair damaged motor.
	No oil pressure input.	Check oil pressure connector and tube.
	The system did not input sufficient oil pressure to the hoist	Ensure the oil pressure has output the necessity pressure for the hoist.
	Oil pressure system damaged	Check the oil pressure loop.
	Overload	Lower down the loading to the rated loading.
	Insufficient pressure or oil flow.	Check the pressure for both side of the hydraulic motor.
	Hoist Internal mechanical error or jammed.	Loosen the screws from tie bars, rotate the drums and make sure the drum can be rotated and not jammed. Finally fasten tight the screws.
	Brake jammed and cannot be free spooled.	Dismantling brake assembly, and then change or repair brake assembly.
The hoist cannot be functioned.	Motor damaged	Dismantling motor, and then change or repair damaged motor.
	Brake assembly mechanical error and jammed.	Dismantling brake assembly, and then change or repair brake assembly.
	Gear box damaged for internal gear assembly.	Dismantling gearbox, and then change or repair gearbox.
	Transmission system damaged.	Dismantling the whole hoist, and then change the damaged parts
Oil leakage	Damaged hydraulic motor axial sealing	Change or repair motors
	Oil pressure tube or connectors loosen	Check hydraulic tube and connector, change or fasten tightly.
Abnormal sound and noise	Insufficient lubricants for gear box	Replace the new lubricants.
	Oil pressure too high or too low.	Check the hydraulic pressure, and adjust to the correct value.
Cannot stop immediately	Brake assembly damaged	Change or repair the brake assembly.

COMEUP WINCH

COMEUP INDUSTRIES INC.

No.139, Jieyukeng Rd., Ruifang Dist., New Taipei City 22453, Taiwan

Tel: +886-2-24971788 Fax: +886-2-24971699

E-mail: info@comeup.com.tw

<http://www.comeupwinch.com>

PN 882956 Ver:1

Specifications subject to change without notice.